

SMD Single high rate CAN isolation transceiver module

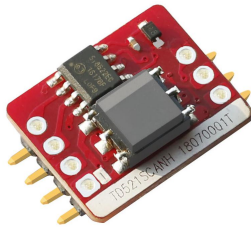

RoHS



FEATURES

- Small size, SMD package
- Two- port isolation (3.0kVDC)
- High baud rate up to 1 Mbps
- Operating temperature range: -40°C to +105°C
- The bus is able to support 110 nodes at maximum
- Set isolation and ESD bus protection in one
- EN60950 approval

TD321SCANH / TD521SCANH, the main function is to convert TTL / CMOS level to CAN bus differential level, to achieve signal isolation; is a use of IC integrated technology, set power isolation, signal isolation, CAN transceiver and bus protection in one CAN bus transceiver module, can achieve 3000VDC electrical isolation. Products using SMD packaging technology, enabling customers to easily automated processing. Products can be easily embedded in the user equipment, so that equipment can easily achieve CAN bus network connectivity.

Selection Guide

Certification	Part No.	Power input (VDC)	Baud rate (bps)	Static Current (mA)	Maximum Operating Current (mA)	Bus Maximum Voltage (VDC)	Number of Nodes
CE	TD321SCANH	3.3	40k-1M	30	60	±58	110
	TD521SCANH	5	40k-1M	35	68	±58	110

Limit Specifications

Item	Operating Conditions	Min.	Typ.	Max.	Unit
Input Surge Voltage (1sec.max.)	3.3V series	-0.7	--	5	VDC
	5.0V series	-0.7	--	7	
Pin Welding Resistance Temperature	Welding time: 10s (Max.)	--	--	300	°C
Reflow Soldering Temperature		Peak temp. ≤245°C, maximum duration time ≤60s at 217°C. For actual application, please refer to IPC/JEDEC J-STD-020D.1.			

Input Specifications(3.3V series)

Item	Symbol	Min.	Typ.	Max.	Unit
Power Supply Input Voltage	VCC	3.15	3.3	3.45	VDC
TXD Logic Level	High-level	V _{IH}	0.7V _{CC}	3.6	
	Low-level	V _{IL}	0	0.8	
RXD Logic Level	High-level	V _{OH}	V _{CC} -0.4	-	
	Low-level	V _{OL}	0	0.4	
TXD Drive Current	I _r	2	--	--	
RXD Output Current	I _r	--	--	10	
Serial Interface	Standard CAN controller interface for +3.3V				

Input Specifications(5.0V series)

Item	Symbol	Min.	Typ.	Max.	Unit
Power Supply Input Voltage	VCC	4.75	5	5.25	VDC
TXD Logic Level	High-level	V _{IH}	0.7V _{CC}	5.5	
	Low-level	V _{IL}	0	0.8	
RXD Logic Level	High-level	V _{OH}	V _{CC} -0.4	-	
	Low-level	V _{OL}	0	0.4	
TXD Drive Current	I _r	2	--	--	
RXD Output Current	I _r	--	--	10	
Serial Interface	Standard CAN controller interface for +5.0V				

Transmission Specifications

Item	Symbol	Min.	Typ.	Max.	Unit
Data Delay	TXD Transmit Delay	tr	55	115	ns
	RXD Receive Delay	tr	65	135	
	Cycle Delay	t _{PRO(TXD-RXD)}	120	250	
Dominant Timeout		0.3	1	12	mS

Output Specifications

Item	Symbol	Min.	Typ.	Max.	Unit	
Dominant Level (Logic 0)	CANH	V _{(OD)CANH}	2.75	3.5	4.5	VDC
	CANL	V _{(OD)CANL}	0.5	1.5	2.25	
Recessive Level (Logic 1)	CANH	V _{(OR)CANH}	2	2.5	3	
	CANL	V _{(OR)CANL}	2	2.5	3	
Differential Level	Dominant Level (Logic 0)	V _{diff(d)}	1.5	2	3	
	Recessive Level (Logic 1)	V _{diff(r)}	-0.05	0	0.05	
Bus Pin Maximum Withstand Voltage	V _x	-58	--	+58		
Bus transient voltage	V _{trt} , Meet ISO7637-3 standard	-150	--	+100		
Bus Pin Leakage Current	(VCC=0V, V _{CANH/L} =5V)	-5	--	5	uA	
Differential load resistance	R _L	45	60	65	Ω	
Differential Input Impedance	R _{diff}	19	30	52	kΩ	
CAN Bus Interface	Meet ISO/DIS 11898-2 standard Twisted-pair output					

General Specifications

Item	Operating Conditions	Value
Isolation Voltage	Testing for 1 minute, leakage current <1mA,	3.0kVDC
Insulation Resistance	Isolation voltage 500VDC	1000MΩ (input-output)
Operating Temperature		-40°C to +105°C
Transportation and Storage Temperature		-50°C to +125°C
Operating Humidity	Non-condensing	10%-90%
Safety Standard		EN60950
Safety Certification		
Safety Class		CLASS III

Physical Specifications

Dimensions	SMD8 (21.80*14.80*7.20mm)
Weight	1.90g (Typ.)
Cooling Method	Free air convection

EMC Specifications

EMI	CE	CISPR32/EN55032	CLASS A (see Fig.3)	
EMS	ESD	IEC/EN 61000-4-2	Contact ±4kV (Bare component, Signal port)	Perf. Criteria A
	RS	IEC/EN 61000-4-3	10V/m (Bare component)	Perf. Criteria A
	EFT	IEC/EN 61000-4-4	±2kV (Bare component, Signal port)	Perf. Criteria B
	Surge	IEC/EN 61000-4-5	±2kV (Bare component, Signal port)	Perf. Criteria A
	CS	IEC/EN 61000-4-6	3Vr.m.s (Bare component)	Perf. Criteria A

Application Precautions

1. Please read the instructions carefully before use; contact our technical support if you have any problem;
2. Do not use the product in hazardous areas;
3. Use DC power supply for the product and 220V AC power supply is prohibited;
4. Do not dismount and assemble the product without permission to avoid failure or malfunction of equipment;

After-sales service

1. Ex-factory inspection and quality control have been strictly conducted for the product; if there occurs abnormal operation or possibility of failure of internal module, please contact the local representative or our technical support;
2. The warranty period for the product is 3 years as calculated from the date of delivery. If any quality problem occurs under normal use within the warranty period, the product can be repaired or changed for free.

Applied circuit

Refer to the CAN Industrial Bus Interface Isolating Module Application Manual.

Design Reference

1. Typical application circuit

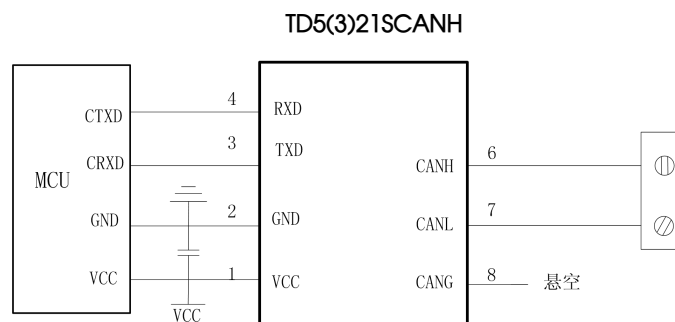

Fig. 1

In general, the module, which is properly connected to the power supply, CAN controller and CAN bus network interface, can be used directly by customers without adding peripheral circuits. Figure 1 shows a typical application circuit connection for a module.

Notes: The CAN controller logic level should be compatible with TD5(3)21SCANH isolated CAN transceiver module.

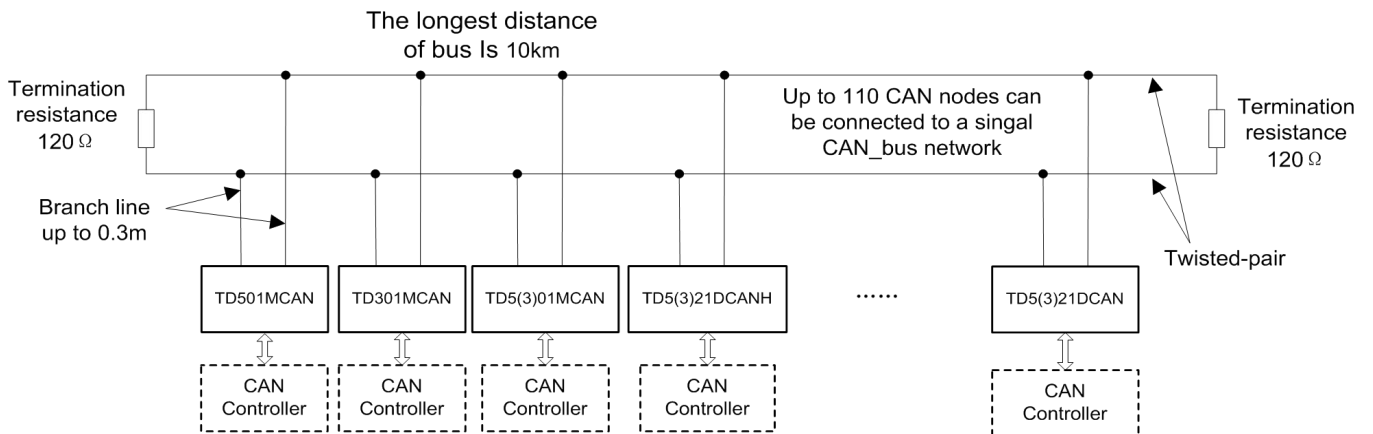
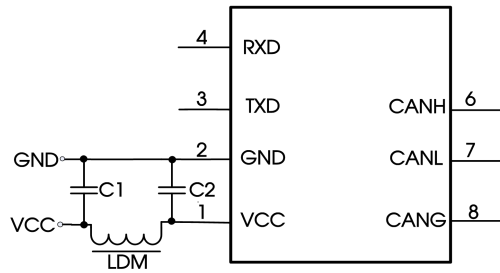

Fig. 2

As shown in Figure 2, a single CAN-bus network can connect up to 110 single-channel TD_CAN isolated CAN transceiver modules. The universal type module can support a max. communication distance of 10km while the high-speed type module can support a max communication distance of 1km with baud rate beyond 40kbps. If looking to access more nodes or longer communication distance, it can be achieved by using CAN repeaters or other expansion equipment.

Notes: The communication distance of the bus is related to the communication speed and field application. It can be designed according to the actual application and reference standard. The communication cable is recommended to twisted pair or shielded twisted pair and should stay away from the interference source. For long-distance communication, the terminal resistance value needs to be selected according to the communication distance and the cable impedance and the number of nodes.



Components	Parameter
C1 C2	1uF/16V
LDM	CD43-12uH

Fig.3

2. Recommended port protection circuit

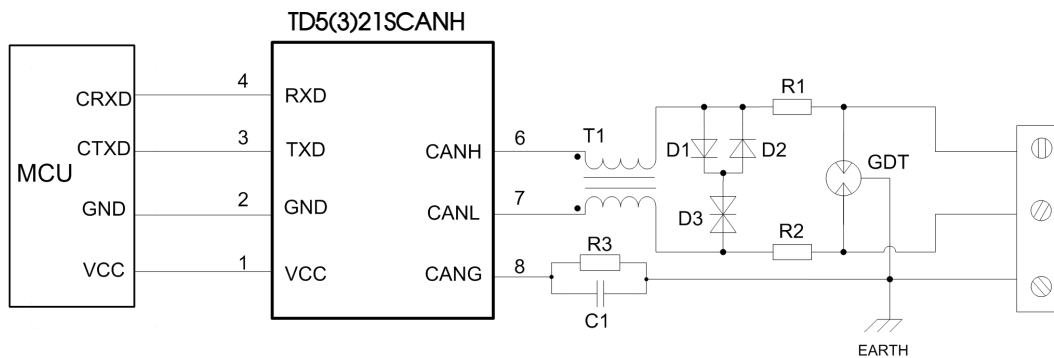

Fig.4

Notes: Twisted pair shield grounded reliably.

Parameter declaration:

Components	Recommended parameters	Components	Recommended parameters
R3	1MΩ	R1、R2	2.7Ω /2W
C1	102,2kV	D1、D2	1N4007
T1	ACM2520-301-2P	D3	SMBJ15CA
GDT	B3D090L		

When the module is used in harsh field environment, it is susceptible to large energy of lightning strike. In this case, it is necessary to add protection circuit to the CAN signal port to protect the module from damage and ensure the reliability of bus communication. Figure 4 provides a recommended protection circuit design for high-energy lightning surges, with a degree of protection related to the selected protection device. Parameter description lists a set of recommended circuit parameters, which can be adjusted according to the actual application situation. Also, when using the shielded cable, the reliable single-point grounding of the shield must be achieved.

Notes: This recommended parameter is only the recommended value, which is subject to the actual application.

Recommended R1, R2 use PTC, D1, D2 use fast recovery diodes.

3. For more information, please find the application note on www.mornsun-power.com

Dimensions and Recommended Layout

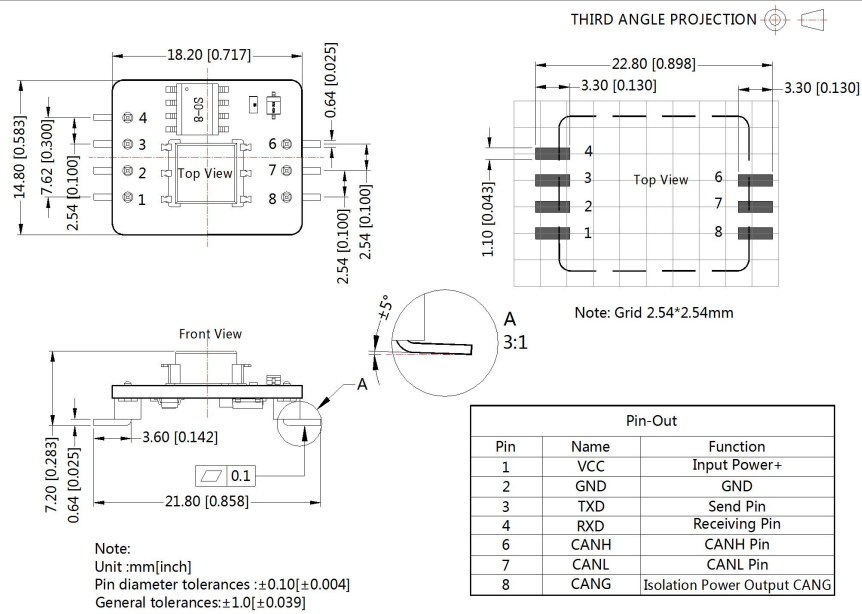

Package diagram:

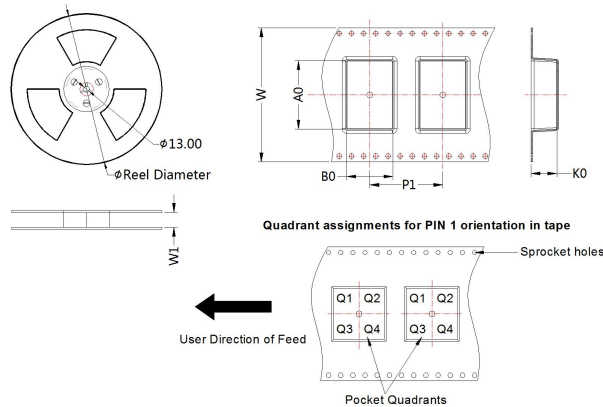

Device	Package Type	Pin	SPQ	Reel Diameter (mm)	Reel Width W1 (mm)	A0 (mm)	B0 (mm)	K0 (mm)	P1 (mm)	W (mm)	Pin1 Quadrant
TDx21S485	SMD	9	300	330.0	44.4	22.6	15.6	8.5	24.0	44.0	Q1
TDx21S485H(-E)	SMD	9	300	330.0	44.4	22.6	15.6	8.5	24.0	44.0	Q1
TDx21S485H-A	SMD	8	300	330.0	44.4	22.6	15.6	8.5	24.0	44.0	Q1
TDx21SCANH	SMD	7	300	330.0	44.4	22.6	15.6	8.5	24.0	44.0	Q1
TDx21DSANH	SMD	7	300	330.0	44.4	22.6	15.6	8.5	24.0	44.0	Q1

Notes:

1. Packing information please refer to Product Packing Information which can be downloaded from www.mornsun-power.com. Packing bag number: 58240012;
2. Unless otherwise specified, data in this datasheet should be tested under the conditions of Ta=25°C, humidity<75%RH when inputting nominal voltage and outputting rated load;
3. PCB surface may be micro-color difference, is a normal phenomenon, does not affect the use of the product;
4. All index testing methods in this datasheet are based on our Company's corporate standards;
5. The performance indexes of the product models listed in this datasheet are as above, but some indexes of non-standard model products will exceed the above-mentioned requirements, and please directly contact our technician for specific information;
6. We can provide product customization service;
7. Products are related to laws and regulations: see "Features" and "EMC";
8. Our products shall be classified according to ISO14001 and related environmental laws and regulations, and shall be handled by qualified units.

Mornsun Guangzhou Science & Technology Co., Ltd.

Address: No. 5, Kehui St. 1, Kehui Development Center, Science Ave., Guangzhou Science City, Luogang District, Guangzhou, P. R. China
Tel: 86-20-38601850-8801 Fax: 86-20-38601272 E-mail: Info@mornsun.cn