

QP12W05S-37 Hybrid Integrated IGBT Driver

QP12W05S-37 is a hybrid integrated IGBT driver designed for driving IGBT modules. This device is a fully isolated gate drive circuit consisting of an optimally isolated gate drive amplifier and an isolated DC-to-DC converter. The gate driver provides an over-current protection function based on desaturation detection and fault output.

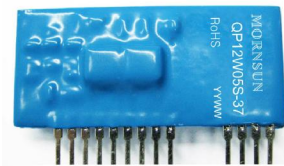

RoHS

Features

- I Built in high CMRR opto-coupler (CMR: Typical: 30kV/μs, Min.:15kV/μs)
- I Single supply drive topology
- I Built in the isolated type DC/DC converter for gate drive
- I SIP package
- I CMOS&TTL compatible
- I Electrical isolation voltage between input and output is 3750VRMS (for 1 minute)
- I Built in short circuit protection circuit with a pin for fault output
- I Soft turn-off time is adjustable
- I The drive signal is ignored in the blocking time and the protection circuit reset at the end of it
- I Controlled time detect short circuit is adjustable
- I Switching frequency up to 20kHz

Application

- I General-purpose Inverter
- I AC Servo Systems
- I Uninterruptable Power Supplies(UPS)
- I Welding Machines

Recommended modules

- I 600V Series IGBT(up to 600A)
- I 1200V Series IGBT(up to 400A)
- I 1700V Series IGBT(up to 200A)

MORNSUN Science & Technology Co.,Ltd.

Address: No. 5, Kehui St. 1, Kehui development center, Science Ave., Guangzhou Science City, Luogang district, Guangzhou,P.R.China.

Tel: 86-20-38601850

Fax:86-20-38601272

[Http://www.mornsun-power.com](http://www.mornsun-power.com)

Absolute Maximum Ratings

Item	Test Conditions	Ratings	Units
Supply Voltage	V _D DC	16	V
Input Current	I _{in} Between pin3 and pin4	25	mA
Output Voltage	V _O When the Output voltage "H"	V _{CC}	V
Output Current	I _{g on} Pulse width 2μs I _{g off} Frequency f=20kHz	+5	A
		-5	A
Isolation Voltage	V _{ISO} Sine wave voltage 50Hz/60 Hz,1 min.	3750	V
Operation Temperature	T _{op}	-40 ~ +70	°C
Storage Temperature	T _{st}	-50 ~ +125	°C
Fault Output Current	I _{FO} Pin5 input current	20	mA
Input Voltage	V _{R1} Applied pin13	50	V

Notes: 1. Ta=25°C; V_D=15V, unless otherwise specified.

Electrical Characteristic

Characteristics	Test Conditions	Limit			Units
		Min	Typ.	Max	
Supply Voltage	V _D Recommended Range	14.5	15	15.5	V
"H" input current	I _{IH} Recommended Range	10	16	20	mA
Switching frequency	f Recommended Range	0		20	kHz
Gate resistant	R _g Recommended Range	2			Ω
Gate supply voltage	V _{CC} V _D =15V	14.5		18.0	V
	V _{EE} V _D =15V	-7		-10	V
"H" output voltage	V _{OH} 10KΩconnected between pin9-11	13.5	15.3	17.0	V
"L" output voltage	V _{OL} 10KΩconnected between pin9-11	-6		-10	V
"L-H" propagation delay time	t _{PLH} I _{IH} =10mA		0.5	1	μs
"L-H" rise time	t _r I _{IH} =10mA		0.3	1	μs
"H-L" propagation delay time	t _{PHL} I _{IH} =10mA		1	1.3	μs
"H-L" fall time	t _f I _{IH} =10mA		0.3	1	μs
Protection threshold voltage	V _{OCP} V _D =15V		9.5		V
Protection reset time	t _{timer} Between start and cancel	1	1.4	2	ms
Fault output current	I _{FO} Pin15 input current, R=4.7K		5		mA
Short-circuit detection time delay	T _{trip1} Pin 13: ≥15V, Pin 16:open		1.6		μs
Soft turn-off time	T _{of} PIN 13≥15V, Pin 14:open		4.5		μs
SC detect voltage	V _{SC} Collector voltage of module	15			V

Notes: 1. Ta=25 °C, V_D=15V, R_g=5Ω. unless otherwise specified
2. "H" represents high level; "L" represents low level.

Definition of Characteristics

1) Operation of short circuit protection

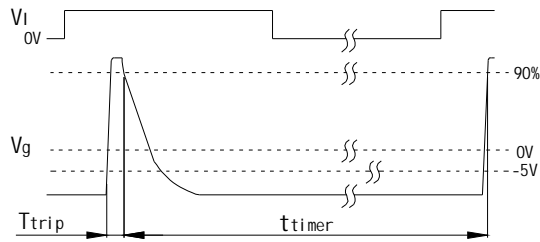

2) Switching operation

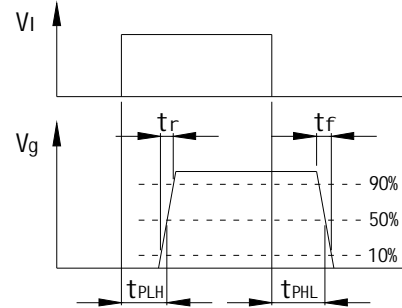

Definition of Adjustment

1) Adjustment of soft turn-off time:

(Operation of short circuit protection)

When a desaturation is detected the hybrid gate driver performs a soft shutdown of the IGBT. The Soft turn-off time is 4.5μs. You can connect an Rf or Cf to adjust the Soft turn-off time. (Connecting Rf will increase the soft turn-off time and connecting Cf will decrease the soft turn-off time.) The soft turn-off time must be set $2.5\mu\text{s} < T_{cf} < 10\mu\text{s}$. Please refer to the below table.

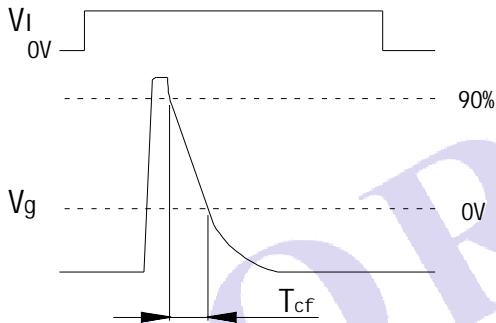

Rf (Ω)	Tcf (μs)	Cf (nF)	Tcf(μs)
—	4.5	—	4.5
1500	4.0	1	4.9
500	3.5	3.3	5.3
300	3.0	10	6.5
110	2.5	22	9.3

2) Adjustment of short-circuit detection time delay

(Operation of short circuit protection)

The short-circuit detection time delay is defined between the time in which a desaturation is detected and the time in which the gate voltage fall down to 90% of extent. This diver have a minimum short-circuit detection time delay, and you can adjust the short-circuit detection time delay by connecting the capacitor (Ctrip) between PIN12 and 16. But the short-circuit detection time delay must be set less than 3.5μs. Please refer to below table.(the data only for refer)

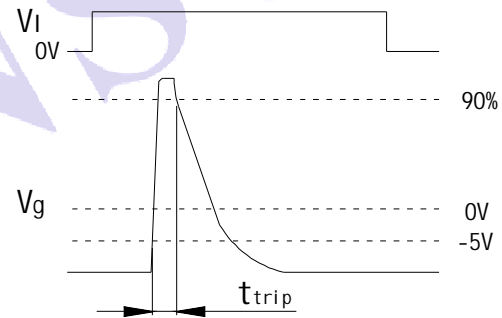

Ctrip (nF)	Ttrip(μs)
—	1.6
0.33	1.8
1.0	2.2
2.2	2.4
3.3	2.6

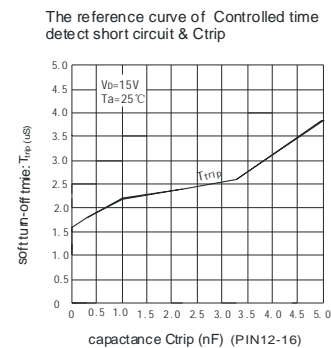
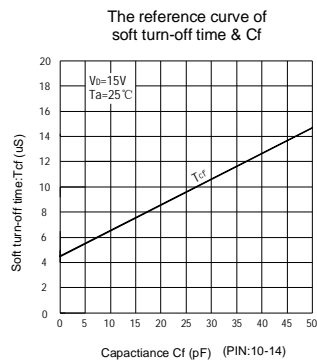
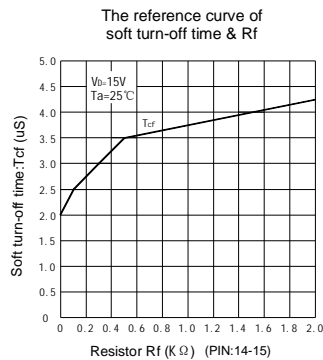

Outline Dimensions

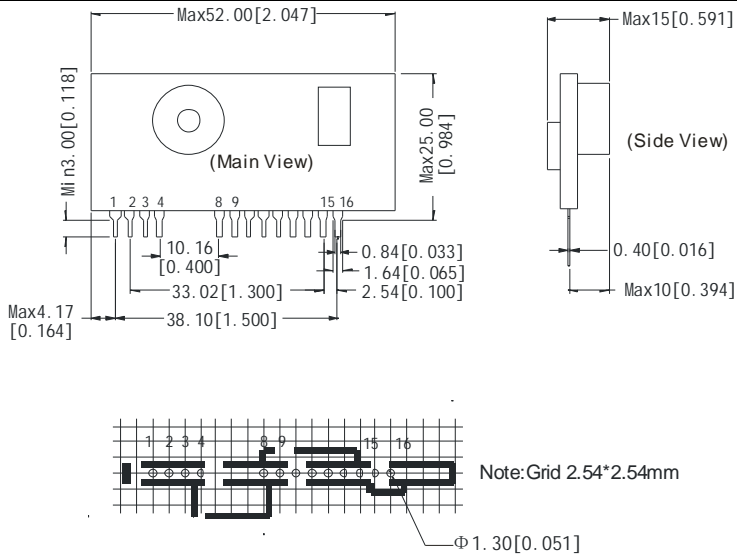

Note:
Unit: mm[inch]
Pin position tolerances : ±0.10mm [±0.004inch]
General tolerances ±0.30mm [±0.012inch]

Pin Function

Pin	Description
1	Power supply(+)
2	Power supply(-)
3	Drive signal input(+)
4	Drive signal input(-)
8	DC/DC converter output(+)
9	DC/DC converter output(COM)
10	DC/DC converter output(-)
11	Drive output
12	Collector of internal power tube
13	Detect of short circuit
14	Adjustment of Soft turn-off time
15	Fault signal output
16	Adjustment of short-circuit detection time delay

Package diagram

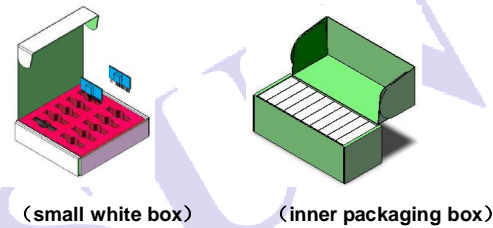

(small white box)

(inner packaging box)

Small white box dimensions: L*W*H=163*150*35mm
Packaging quantity: 10PCS
Inner packaging box dimensions: L*W*H=430*175*160mm
Packaging quantity: 100PCS
Outer packaging carton dimensions: L*W*H=560*450*520mm
Packaging quantity: 900PCS

Application Examples

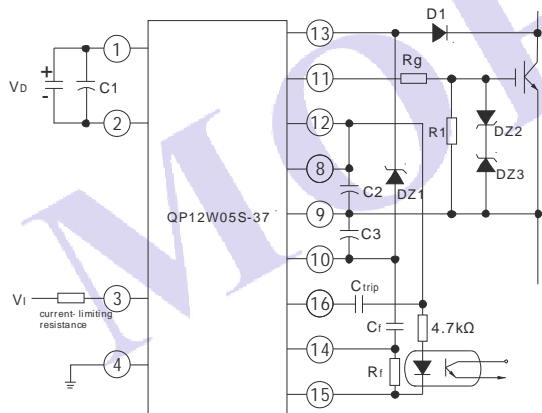

$V_D=15V$
 $V_I=5V \pm 5\%$
C1: 100 μ F (Low impedance)
C2: 100 μ F (Low impedance)
C3: 100 μ F (Low impedance)
Ctrip: Depend on need.
Cf: Depend on need
Rf: Depend on need
Rg: 5 Ω (Adjustable)
R1: 10K Ω 0.25W
DZ1: 30V
DZ2, DZ3: 18V
D1: Fast recovery diode ($t_{rr} \leq 0.2\mu s$)

Application Notes

- The isolated DC/DC converter is only for the gate drive;
- The IGBT gate-emitter drive loop wiring must be shorter than 1 meter;
- The IGBT gate-emitter drive loop wiring should be twisted;
- If large voltage spike is generated at the collector of the IGBT, the IGBT gate resistor should be increased;
- The external capacitors or resistors should be set as close as possible to the Hybrid IC;
- The external C_f or R_f should be set as close as possible to the Hybrid IC, and the value can not exceed the recommended maximum;
- The peak reverse voltage of the diode D1 (to connect PIN13) must be higher than the peak value of the IGBT collector voltage;
- When recovery current flow in D1, PIN13 is applied high voltage. In the case, counterplan for protection which insert a zener diode between PIN10 and 13 are necessary like above diagram(DZ1);
- When the built in short-circuit protection circuit need not be used, please connect resistance of 4.7k Ω between PIN9 and 13(D1 and DZ1 are not required).
- The input signal voltage must be less than 5.25V. The higher input signal voltage, the higher input signal current. It will result in more dissipation. The input port is a circuit composed of a high-speed optocoupler series with a 150ohm resistor. Practically, a current-limiting resistor is inserted, which value can be obtained according to the following equation:

$$R = \frac{V_{in} - 1.7V}{16mA} - 150ohm$$