

7.2W, Ultra wide input voltage, isolated & regulated two output DC/DC Converter for IGBT driver



Patent Protection **RoHS**

FEATURES

- Ultra Wide input voltage range (4:1)
- High efficiency up to 85%
- Input-Output Isolation voltage: 4.2kVAC
- Output-Output Isolation voltage: 3.0kVAC
- Operating temperature range: -40°C to +105°C
- Input under-voltage protection, output short-circuit protection, over-voltage protection
- No-load operation allowed
- Reinforced Insulation design
- IGBT dedicated regulated DC-DC converter

QAU series are DC-DC converters for IGBT drivers, offer 7.2W of output, with output over-voltage protection and short-circuit protection. General application includes:

1. Universal converter
2. AC servo drive system
3. Electric welding machine
4. Uninterruptible power supply (UPS)

Selection Guide

Part No.	Input		Output		Efficiency (%Typ.) @ Full Load	Max. Capacitive Load ^① (μF)
	Input Voltage(VDC) (Range)	Input Current(mA, Typ.) Full Load/No Load	Output Voltage (VDC)Vo1/Vo2	Output Current (mA) (Max./Min.)		
QAU242D2G	24 (9-36)	353/10	24/24	150/0	85	470

Notes: ①The capacitive loads of two outputs are identical.

Input Specifications

Item	Operating Conditions	Min.	Typ.	Max.	Unit
Input Current (full load / no-load)	Nominal input voltage	--	353/10	--	mA
Reflected Ripple Current	Nominal input voltage	--	55	--	
Input impulse Voltage (1sec. max.)		-0.7	--	50	VDC
Starting Voltage		--	--	9	
Input Under-voltage Protection		5.5	6.5	--	
Input Filter		Capacitive filter			
Hot Plug		Unavailable			

Output Specifications

Item	Operating Conditions	Min.	Typ.	Max.	Unit	
Output Power		0	--	7.2	W	
Output Voltage Accuracy	5%-100% load	Main output Vo1	--	±1	±2.5	%
		Supplement output Vo2	--	±1	±2.5	
Line Regulation	Full load, the input voltage is from low to high	Main output Vo1	--	±0.2	±0.5	
		Supplement output Vo2	--	±0.8	±1.2	
Load Regulation	5%-100% load	Main output Vo1	--	±0.5	±1	
		Supplement output Vo2	--	±1	±1.5	
Transient Recovery Time	25% load step change, nominal input voltage	--	300	500	μs	
Transient Response Deviation		--	±3	±5	%	
Temperature Coefficient	Full load	--	--	±0.03	%/°C	
Ripple & Noise*	20MHz bandwidth	--	75	150	mV p-p	
Over-voltage Protection	Input voltage range	110	--	160	%Vo	
Short circuit Protection		Continuous, self-recovery				

Note: *Ripple and noise are measured by "parallel cable" method, please see DC-DC Converter Application Notes for specific operation.

General Specifications

Item	Operating Conditions	Min.	Typ.	Max.	Unit
Insulation Voltage	Input-output, with the test time of 1 minute and the leak current lower than 1mA	4200	--	--	VAC
	output-output, with the test time of 1 minute and the leak current lower than 1mA	3000			
Insulation Resistance	Input-output, isolation voltage 500VDC	1000	--	--	MΩ
Isolation Capacitance	Input-output, 100kHz/0.1V	--	15	--	pF
Operating Temperature	Derating when operating temperature up to $\geq 75^{\circ}\text{C}$ (see Fig. 1)	-40	--	105	°C
Storage Temperature		-55	--	125	
Pin Welding Resistance Temperature	Welding spot is 1.5mm away from the casing, 10 seconds	--	--	300	
Storage Humidity	Non-condensing	5	--	95	%RH
Vibration		10-55Hz, 10G, 30 Min. along X, Y and Z			
Switching Frequency (PFM Mode)	PWM mode	--	300	--	kHz
MTBF	MIL-HDBK-217F@25°C	1000	--	--	k hours

Physical Specifications

Casing Material	Black flame-retardant and heat-resistant plastic (UL94 V-0)
Dimension	31.70*20.30*12.65 mm
Weight	13g(Typ.)
Cooling Method	Free air convection

EMC Specifications

EMI	CE	CISPR32/EN55032 CLASS B (see Fig.4-② for recommended circuit)		
	RE	CISPR32/EN55032 CLASS B (see Fig.4-② for recommended circuit)		
EMS	ESD	IEC/EN61000-4-2	Contact $\pm 4\text{kV}$	perf. Criteria B
	EFT	IEC/EN61000-4-4	$\pm 2\text{kV}$ (see Fig.4-① for recommended circuit)	perf. Criteria B
	Surge	IEC/EN61000-4-5	$\pm 2\text{kV}$ (see Fig.4-① for recommended circuit)	perf. Criteria B
	Voltage dips, short interruptions and voltage variations immunity	IEC/EN61000-4-29	0,70%	perf. Criteria B

Product Characteristic Curve

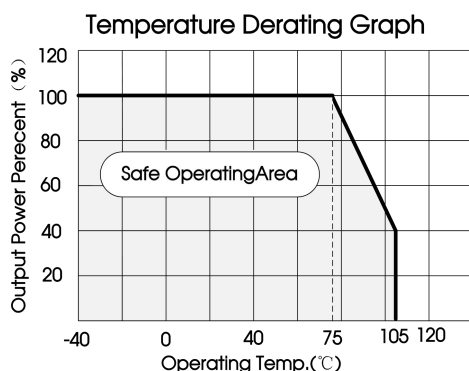
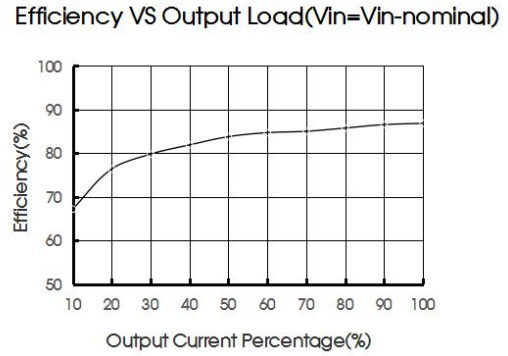
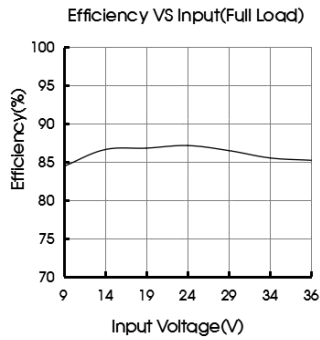

Fig. 1



Design Reference

1. Recommended circuit

All the DC/DC converters of this series are tested according to the recommended circuit (see Fig. 2) before delivery, Two outputs needs the same load.

If it is required to further reduce input and output ripple, properly increase the input & output of additional capacitors C_{in} and C_{out} or select capacitors of low equivalent impedance provided that the capacitance is no larger than the max. capacitive load of the product.

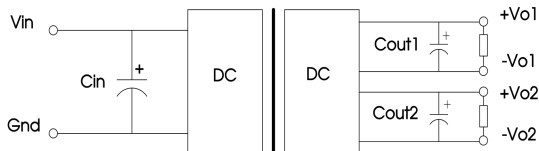

Fig. 2

Vin	24V
Cin	100μF
Cout1	100μF
Cout2	100μF

C1	100uF/63V
C2 /C3/C4/C5	100uF/35V
R1/R2	15K
D1/D2	15V

2. Typical application

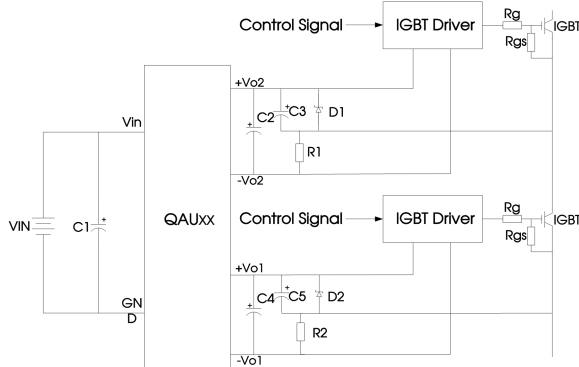

Fig. 3

Application Notes

1. The wire between the converter and IGBT driver must as short as possible.
2. External filter capacitors should be connected as close as possible to the IGBT driver.
3. To ensure the high peak gate current, the filter capacitors should be electrolytic capacitor and ceramic capacitor collocation.
4. The output average power of the IGBT driver should be less than the output power of DC-DC module.
5. When driving the bridge circuit, the Main output Vo1 drives the lower tube, and the Supplement output Vo2 drives the upper tube. If it is reversed, the output voltage will be unstable.

3. EMC solution-recommended circuit

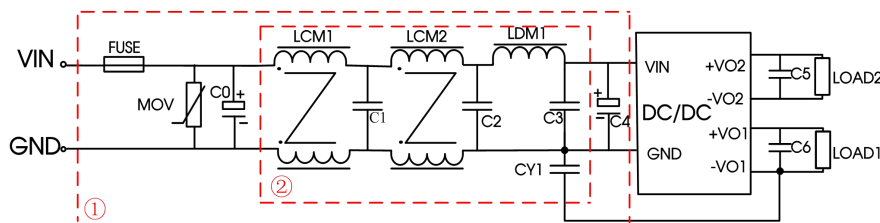

Fig. 4

Model	QAU242D2G
FUSE	Choose according to actual input current
MOV	20D560K
C0、C4	330uF/63V
C1	225K/50V
C2、C3	475K/50V

C5、C6	100uF/50V
CY1	102M/8kV
LCM1	4.8mH/2A
LCM2	2.2mH/2A
LDM1	15uH/2A

- The input and the output of the product are recommended to be connected to electrolytic capacitor. Using tantalum capacitor may cause risk of failure
- The product does not support output in parallel with power per liter or hot-swappable use
- For more information please find the application notes on www.mornsun-power.com

Dimensions and Recommended Layout

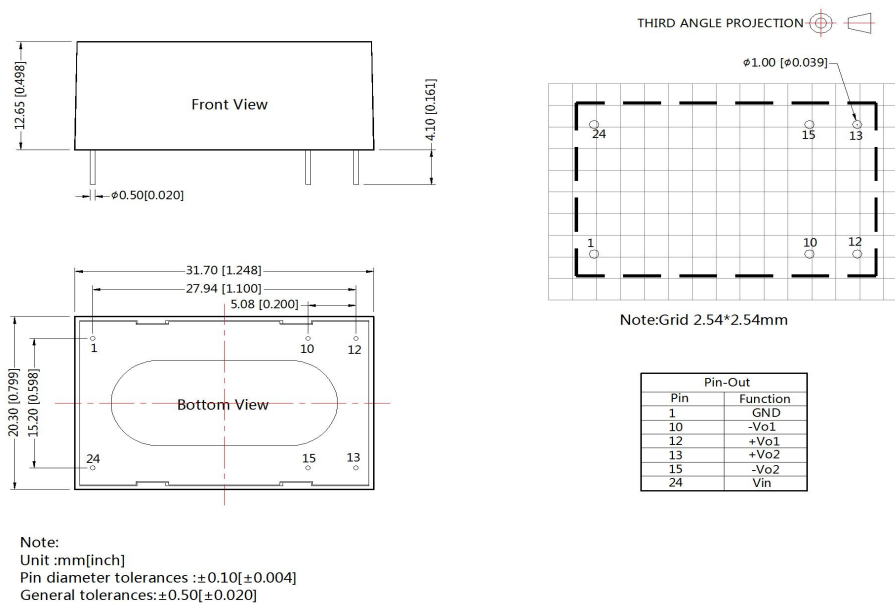

Notes:

- Packing information please refer to Product Packing Information which can be downloaded from www.mornsun-power.com. Packing bag number: 58000150;
- The lead connecting the power supply module and IGBT driver should be as short as possible during use;
- The output filtering capacitor should be as close as possible to the power supply module and IGBT driver;
- The peak of the IGBT driver dedicated power supply gate drive current is high, so low internal resistance electrolytic capacitor is recommended to be used for the power supply module output filter capacitor;
- The average output power of the driver must be lower than that of the power supply module;
- Consider fixing with glue near the module if being used in vibration occasion;
- The max. capacitive load should be tested within the input voltage range and under full load conditions;
- Unless otherwise specified, data in this datasheet should be tested under the conditions of $T_a=25^{\circ}\text{C}$, humidity<75% when inputting nominal voltage and outputting rated load;
- All index testing methods in this datasheet are based on our Company's corporate standards;
- The performance indexes of the product models listed in this manual are as above, please directly contact our technicians for specific information;
- We can provide product customization service;
- Products are related to laws and regulations: see "Features" and "EMC".
- Our products shall be classified according to ISO14001 and related environmental laws and regulations, and shall be handled by qualified units.

Mornsun Guangzhou Science & Technology Co., Ltd.

Address: No. 5, Kehui St. 1, Kehui Development Center, Science Ave., Guangzhou Science City, Luogang District, Guangzhou, P. R. China
Tel: 86-20-38601850-8801 Fax: 86-20-38601272 E-mail: info@mornsun.cn