

40W, AC/DC converter



RoHS

FEATURES

- Input voltage range: 85 - 305VAC/100 - 430VDC
- AC and DC dual-use(input from the same terminal)
- High efficiency up to 84%
- Isolation voltage: 3K VAC
- Operating temperature range: -40℃ to +85℃
- Output short circuit, over-current, over-voltage protection

LH40-13Bxx series are 40W efficient environmental-protection AC-DC module power supply, which have advantages such as universal input voltage, accept either AC or DC input, high efficiency, high reliability, low power consumption and high safety isolation. They offer good EMC performance, meet IEC/EN61000-4, CISPR32/EN55032, UL62368 and EN62368 standards. The series products are widely used in industries such as industrial control, electricity, office.

Note: Please refer to Design Reference when module being used in a bad EMC environment.

Selection Guide

Part No.	Output Power	Nominal Output Voltage and Current(Vo/Io)	Efficiency (277VAC, %/Typ.)	Max. Capacitive Load(μF)
LH40-13B12	40W	12VDC/3333mA	84	9000
LH40-13B24		24VDC/1667mA	84	2000

Input Specifications

Item	Operating Conditions	Min.	Typ.	Max.	Unit
Input Voltage Range	AC input	85	--	305	VAC
	DC input	100	--	430	VDC
Input frequency		47	--	63	Hz
Input current	115VAC	--	--	1.0	A
	277VAC	--	--	0.5	
Inrush current	115VAC	--	30	--	
	277VAC	--	70	--	
Hot Plug		Unavailable			

Output Specifications

Item	Operating Conditions	Min.	Typ.	Max.	Unit
Output Voltage Accuracy		--	±2	--	%
Line Regulation	Full load	--	±0.5	--	%
Load Regulation	0% - 100% load	--	±1	--	
Ripple & Noise*	20MHz bandwidth (peak-peak value)	--	50	100	mV
Temperature Coefficient		--	±0.02	--	%/℃
Stand-by Power Consumption		--	--	0.8	W
Short Circuit Protection		Continuous, self-recovery			
Over-current Protection		≥ 110%Io self-recovery			
Over-voltage Protection	12V	≤ 16VDC			
	24V	≤ 35VDC			
Min. Load		0	--	--	%
Trim		--	--	±10	
Hold-up Time	115VAC input	--	15	--	ms
	277VAC input	--	60	--	

Note: * Ripple and noise are measured by "parallel cable" method, please see AC-DC Converter Application Notes for specific operation.

General Specifications

Item	Operating Conditions	Min.	Typ.	Max.	Unit
Isolation Voltage	Input-output	3000	--	--	VAC
Operating Temperature		-40	--	+85	°C
Storage Temperature		-40	--	+85	
Storage Humidity		--	--	95	%RH
Welding Temperature	Wave-soldering	260 ± 5°C; time: 5 - 10s			
	Manual-welding	360 ± 10°C; time: 3 - 5s			
Switching Frequency		--	65	--	kHz
Power Derating	-40°C to -30°C(LH40-13B12)	3.0	--	--	% / °C
	+55°C to +70°C(LH40-13B12)	3.67	--	--	
	+70°C to +85°C(LH40-13B12)	1.67	--	--	
	-40°C to -30°C(LH40-13B24)	2.0	--	--	
	+55°C to +70°C(LH40-13B24)	2.7	--	--	
	+70°C to +85°C(LH40-13B24)	2.33	--	--	
	85-100VAC	1.33	--	--	% / VAC
277-305VAC	0.72	--	--		
Safety Standard		IEC62368/EN62368/UL62368			
Safety Class		CLASS II			
MTBF		MIL-HDBK-217F@25°C > 300,000 h			

Physical Specifications

Casing Material	Black flame-retardant and heat-resistant plastic (UL94V-0)
Dimensions	89.00*63.50*25.00 mm
Weight	225g (Typ.)
Cooling Method	Free air convection

EMC Specifications

EMI	CE	CISPR32/EN55032	CLASS B	
	RE	CISPR32/EN55032	CLASS B	
EMS	ESD	IEC/EN61000-4-2	Contact ±6KV/Air ±8KV	Perf. Criteria B
	RS	IEC/EN61000-4-3	10V/m	perf. Criteria A
	EFT	IEC/EN61000-4-4	±2KV	perf. Criteria B
		IEC/EN61000-4-4	±4KV (See Fig. 2 for recommended circuit)	perf. Criteria B
	Surge	IEC/EN61000-4-5	line to line ±1KV	perf. Criteria B
		IEC/EN61000-4-5	line to line±2KV/ line to ground ±4KV (See Fig. 2 for recommended circuit)	perf. Criteria B
CS	IEC/EN61000-4-6	10Vr.m.s	perf. Criteria A	

Product Characteristic Curve

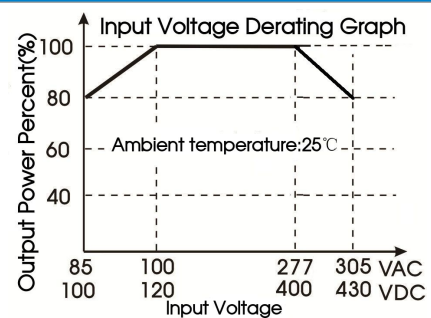
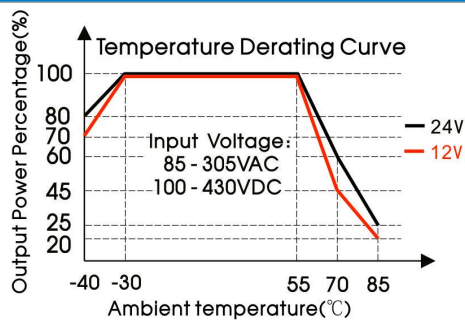

Note:

- ① Input voltage should be derated based on temperature derating when it is 85-100VAC/277-305VAC/100-120VDC/400-430VDC;
- ② This product is suitable for use in natural air cooling environments, if in a closed environment, please contact our company's FAE.

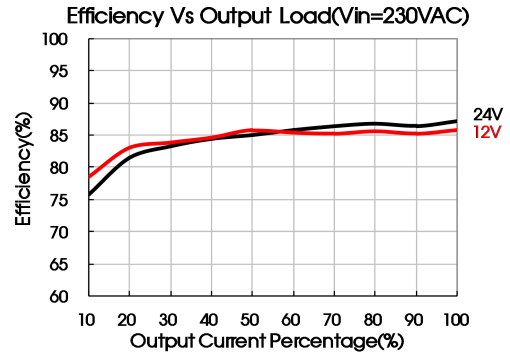
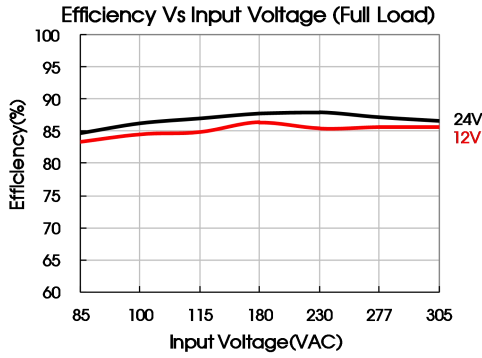

Design Reference

1. Typical application circuit

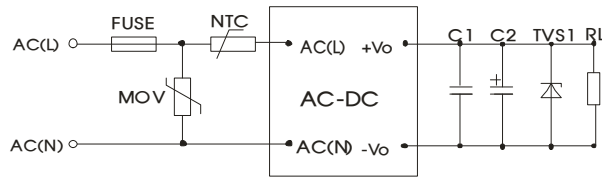

Fig. 1

Model	FUSE	MOV	NTC	C1(μF)	C2(μF)	TVS1
LH40-13B12	3.15A/300VAC, slow fusing, necessary	S10K350	5D-9	1	220	SMBJ20A
LH40-13B24					120	SMBJ30A

Note: Output filtering capacitor C2 is electrolytic capacitors, it is recommended to apply electrolytic capacitor with high frequency and low resistance. For capacitance and current of capacitor please refer to manufacture's datasheet. Capacitor voltage reduced to at least 80%. C1 is ceramic capacitors, which is used to filter high-frequency noise. TVS is a recommended component to protect post-circuits if converter fails.

2. EMC solution-recommended circuit

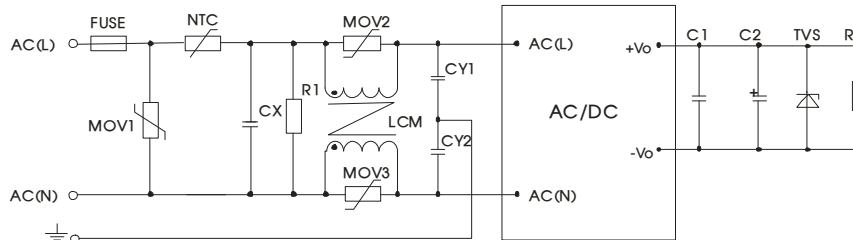
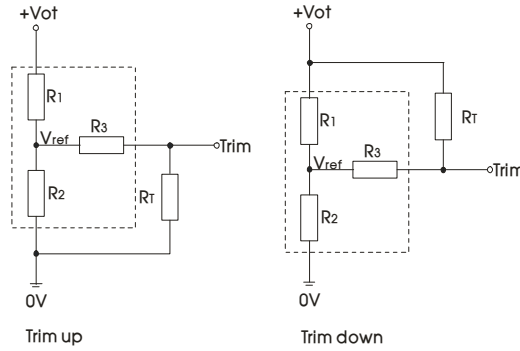

Fig.2 (Output external circuit refer to the typical application circuit)

Element model	Recommended value
MOV1	S14K350
MOV2, MOV3	S07K350
CX	0.15μF/300VAC
CY1	2.2nF/400VAC
CY2	2.2nF /400VAC
R1	1MΩ/2W
LCM	2.2mH, recommended to use MORNSUN's FL2D-10-222;
NTC	5D-14
FUSE	3.15A/300V, slow fusing, necessary

3. Application of Trim and calculation of Trim resistance



Applied circuits of Trim (Part in broken line is the interior of models)

Calculation formula of Trim resistance:

$$\begin{aligned} \text{up: } R_T &= \frac{\alpha R_2}{R_2 - \alpha} - R_3 & \alpha &= \frac{V_{ref}}{V_{ot} - V_{ref}} \cdot R_1 \\ \text{down: } R_T &= \frac{\alpha R_1}{R_1 - \alpha} - R_3 & \alpha &= \frac{V_{ot} - V_{ref}}{V_{ref}} \cdot R_2 \end{aligned}$$

R_T is Trim resistance, α is a self-defined parameter, with no real meaning.

Vout	R1(KΩ)	R2(KΩ)	R3(KΩ)	Vref(V)	Vot(V)
12V	3.83	1	1	2.5	Output voltage after regulation, variation $\leq \pm 10\%$
24V	8.66	1	1	2.5	

4. For more information, Please find the application note on www.mornsun-power.com

Dimensions and Recommended Layout

THIRD ANGLE PROJECTION

Note : Grid 2.54*2.54mm

Pin-Out	
Pin	LH40-13BXX
1	AC(L)
2	AC(N)
3	+Vo
4	No Pin
5	-Vo
6	No Pin
7	Trim

Note:
Unit :mm[inch]
Pin diameter tolerances : $\pm 0.10[\pm 0.004]$
General tolerances: $\pm 0.50[\pm 0.020]$

Notes:

1. Packing information please refer to Product Packing Information which can be downloaded from www.mornsun-power.com. Packing bag number: 58220021;
2. Unless otherwise specified, parameters in this datasheet were measured under the conditions of $T_a=25^{\circ}\text{C}$, humidity<75% with nominal input voltage and rated output load;
3. All index testing methods in this datasheet are based on our Company's corporate standards;
4. We can provide product customization service, please contact our technicians directly for specific information;
5. Products are related to laws and regulations: see "Features" and "EMC";
6. Our products shall be classified according to ISO14001 and related environmental laws and regulations, and shall be handled by qualified units.

Mornsun Guangzhou Science & Technology Co., Ltd.

Address: No. 5, Kehui St. 1, Kehui Development Center, Science Ave., Guangzhou Science City, Luogang District, Guangzhou, P. R. China
Tel: 86-20-38601850-8801 Fax: 86-20-38601272 E-mail: info@mornsun.cn