

Constant current great power buck led driver

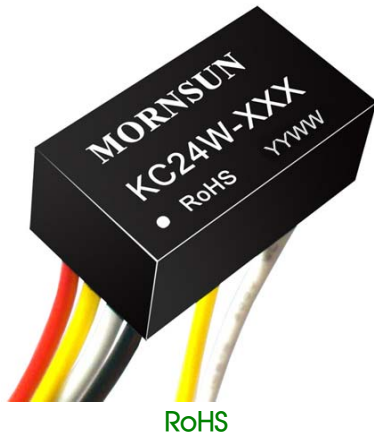

RoHS

FEATURES

- High efficiency up to 96%
- Ultra wide range voltage input (5.5-48 VDC)
- Drive current:300/350/500/600/700mA
- Output Power:10/12/18/21/25W
- Output current accuracy ($\pm 2\%$)
- Output current stability($\pm 1\%$)
- Low Ripple & Noise(<100mV)
- With large capacitive loads(1000 μ F)
- PWM dimming & Analogue dimming
- Remote ON/OFF
- Continuous short circuit protection
- AC-DC, EMC recommended circuit
- Lead wire package, simple and convenient
- Waterproof Level: IP67
- RoHS Compliance

KC24W series is a high-power LED driver designed for the step-down constant current source. With high efficiency, wide input voltage range, high-temperature environment, functional and so on. Contains a PWM dimming, analog dimming and remote shutdown capabilities.It can be widely used in backlight and 12V, 24V, 36V landscape lighting, special lighting controls, commercial lighting, street lighting, home lighting, automotive lighting and other lighting systems. Use of lead type package, allowing customers to use more convenient.

Selection Guide

Part No.	Input		Output		Dimming control	Efficiency (% , Typ).	Max. Capacitive Load(μ F)
	Input Voltage (VDC)	Output Voltage (VDC)	Output Current (mA)				
	Nominal (range)						
KC24W-300 (X1/X2/X3)	24 (5.5-48)	3.3-36	0-300	PWM+Analogue	96	1000	
KC24W-350 (X1/X2/X3)			0-350				
KC24W-500 (X1/X2/X3)			0-500				
KC24W-600 (X1/X2/X3)			0-600				
KC24W-700 (X1/X2/X3)			0-700				

Note:

1. The types without suffix, such as KC24W-300 are four-wire products without analogue dimming+PWM dimming function.
2. The types with suffix X1,such as KC24W-300X1 are five-wire products with analogue dimming function only.
3. The types with suffix X2,such as KC24W-300X2 are five-wire products with PWM dimming function only.
4. The types with suffix X3,such as KC24W-300X3 are six-wire products with analogue dimming+PWM dimming function.

Input Specifications

Item	Operating Conditions	Min.	Typ.	Max.	Unit
Input Voltage Range		5.5	24	48	VDC
Input Voltage Limit	≤ 10 seconds	5	--	55	
Min. Input-output Voltage Drop	$V_{in}=5.5\sim 48V, 1\sim 10LEDs$	2	--	4	
Input Filter		Capacitor filter			

Output Specifications

Item	Operating Conditions	Min.	Typ.	Max.	Unit
Output Power	$I_o=300mA$	0.99	--	10.8	W
	$I_o=350mA$	1.16	--	12.6	
	$I_o=500mA$	1.65	--	18	
	$I_o=600mA$	1.98	--	21.6	
	$I_o=700mA$	2.31	--	25.2	

Output Current Accuracy		--	±2	±5	%
Output Current Stability	Vin=48V, Vo=3.3V~36V	--	--	±1	
Temperature Drift Coefficient	-40℃ to +71℃ ambient	--	--	±0.015	%/℃
Ripple & Noise*	20MHz bandwidth	--	--	100	mVp-p
Internal power dissipation	Vin=24V, 5LEDs	--	--	700	mW
Thermal Impedance		--	60	--	℃/W
Short Circuit Protection		Continuous, automatic recovery			
Note: * Ripple and noise tested with "parallel cable" method, please see <i>DC-DC Converter Application Notes</i> for specific operation methods.					

General Specifications

Item	Operating Conditions	Min.	Typ.	Max.	Unit
Operating Temperature	300mA / 350mA	-40	--	85	℃
	500mA/ 600mA/ 700mA	-40	--	71	
Storage Temperature		-55	--	105	
Lead Temperature	Welding spot is 1.5mm away from the casing, 10 seconds	--	--	265	
Casing Temperature		--	--	100	
Switching Frequency		320	370	420	KHz
MTBF	MIL-HDBK-217F@25℃	1500	--	--	K hours
Thermal Impedance		--	60	--	℃/W

PWM Dimming and Remote on/off Control

Item	Operating Conditions	Min.	Typ.	Max.	Unit	
Analogue Dimming	Control Voltage Range	Vin=5.5-48V	0	--	15	V
	Output Current Range	Vin=5.5-48V	0	--	100	%
	Control Voltage Range	Full on	0.2V±50mV			
		Full off	4.5V±200mV			
Driving Current	Vc=5V	--	--	0.6	mA	
Remote Turn-off	ON	Vin=5.5-48V	Open or 2.8V<Vc<6V			
	OFF	Vin=5.5-48V	Vc<0.6V			
PWM Dimming	PWM dimming Pin suspended voltage	Vin=24V, 5LED	--	3.3	--	V
	PWM dimming Pin Isink	Vc=5V	--	--	1	mA
	PWM dimming Pin Isource	Vc<0.6V	--	1	--	µA
	Turn-off-mode Static Input Current	Vin=24V, Vc <0.6V	--	400	--	
	PWM Dimming Frequency*		--	--	200	Hz

Note: *Refer to "PWM Dimming Control" on page five.

Physical Specifications

Casing Material	Black flame-retardant and heat-resistant plastic (UL94-V0)
Package Dimensions	22.30*12.55*9.10 mm
Weight	four-wire products/ five-wire products/six-wire products 7.10g /7.60g /8.20g (Typ.)
Cooling Method	Free air convection

EMC Specifications

EMI	Conducted Disturbance	CISPR22/EN55022	CLASS B	EN55015 power port (see Fig. 5 for recommended circuit)
	Radiated Emission	CISPR22/EN55022	CLASS B	(see Fig. 5 for recommended circuit)
EMS	Electrostatic Discharge	IEC/EN 61000-4-2	Contact ±2KV	perf. Criteria B
		IEC/EN 61000-4-2	Contact ±6KV (see Fig. 5 for recommended circuit)	perf. Criteria B
	Radiation Immunity	IEC/EN 61000-4-3	10V/m	perf. Criteria A
	EFT	IEC/EN 61000-4-4	±1KV (see Fig. 5 for recommended circuit)	perf. Criteria B

EMS	Surge Immunity	IEC/EN 61000-4-5	±1KV (see Fig. 5 for recommended circuit)	perf. Criteria B
	Conducted Disturbance Immunity	IEC/EN 61000-4-6	3Vr.m.s	perf. Criteria A
	Immunities of voltage dip, drop and short interruption	IEC/EN 61000-4-29	0%-70%	perf. Criteria B

Product Characteristic Curve

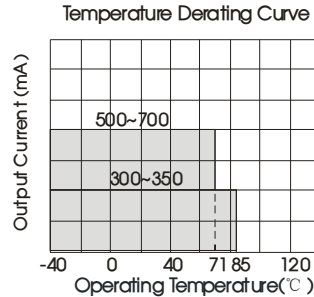
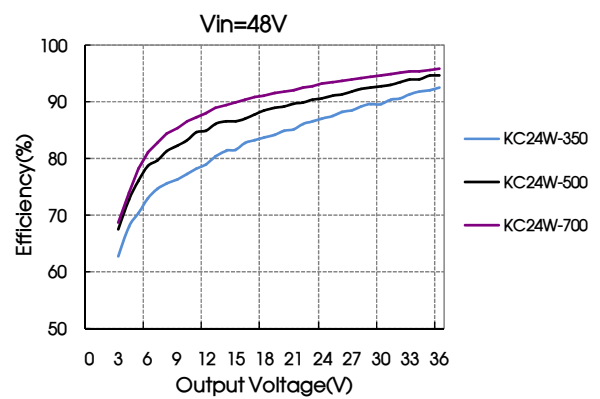
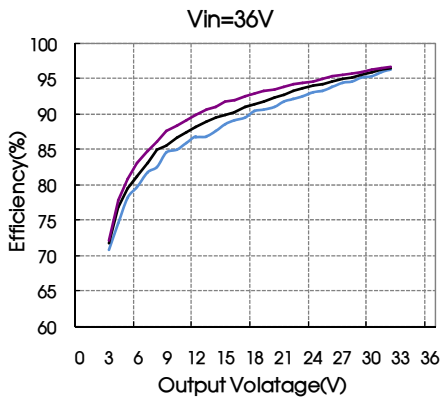
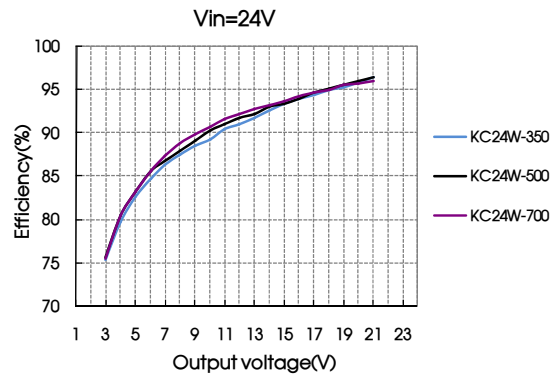
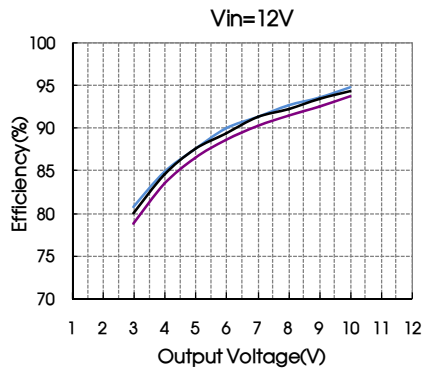

Fig. 1



Design Reference

1. Input/output relationship

Input voltage (VDC)	Output voltage range (VDC)	Constant output current (mA)	Output power (W, Max.)	Input voltage (VDC)	Output voltage range (VDC)	Constant output current (mA)	Output power (W, Max.)
48	3.3-36.0	300	10.80	48	3.3-36.0	350	12.60
36	3.3-32.0	300	9.60	36	3.3-32.0	350	11.20
24	3.3-21.0	300	6.30	24	3.3-21.0	350	7.35
20	3.3-17.0	300	5.10	20	3.3-17.0	350	5.95
15	3.3-13.2	300	3.96	15	3.3-13.2	350	4.62
12	3.3-10.0	300	3.00	12	3.3-10.0	350	3.50
5.5	3.3-4.0	300	1.20	5.5	3.3-4.0	350	1.40

48	3.3-36.0	500	18.00
36	3.3-32.0	500	16.00
24	3.3-21.0	500	10.50
20	3.3-17.0	500	8.50
15	3.3-13.2	500	6.60
12	3.3-10.0	500	5.00
5.5	3.3-4.0	500	2.00
48	3.3-36.0	700	25.20
36	3.3-32.0	700	22.40
24	3.3-21.0	700	14.70
20	3.3-17.0	700	11.90
15	3.3-13.2	700	9.24
12	3.3-10.0	700	7.00
5.5	3.3-4.0	700	2.80

48	3.3-36.0	600	21.60
36	3.3-32.0	600	19.20
24	3.3-21.0	600	12.60
20	3.3-17.0	600	10.20
15	3.3-13.2	600	7.92
12	3.3-10.0	600	6.00
5.5	3.3-4.0	600	2.40

2. Typical application circuit

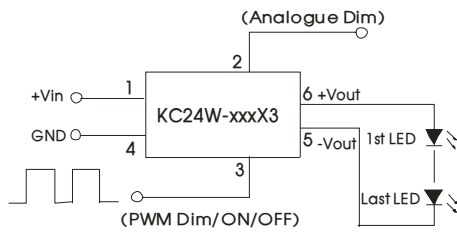

Fig. 2 Application circuits in series

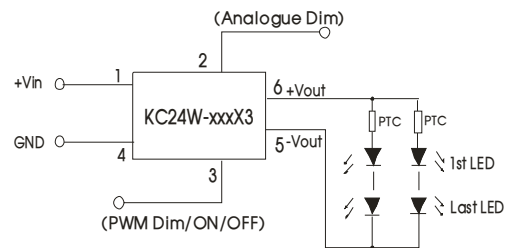

Fig. 3 Application circuits in series and parallel

If it is necessary to protect LED in actual application, you could connect a PTC to the input of every channel or all channels, as shown in Figure 2.
Note: The negative output terminal can't connect GND, or the module may be damaged.

3. Recommended AC input circuit

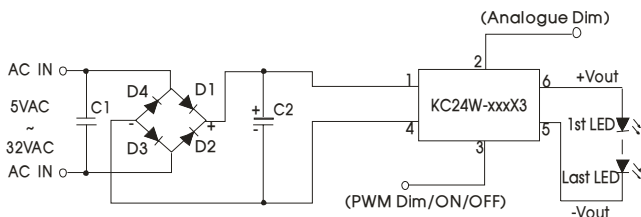

Fig. 4

Components	Specifications
C1	X1 Safety capacitor, 0.1μF /300VAC (QIYA)
C2	100μF /63V Electrolytic capacitor (CapXon)
D1, D2, D3, D4	Rectifier diode 1N4007 1A/1000V D0-41(PANJIT)

4. EMC solution-recommended circuit

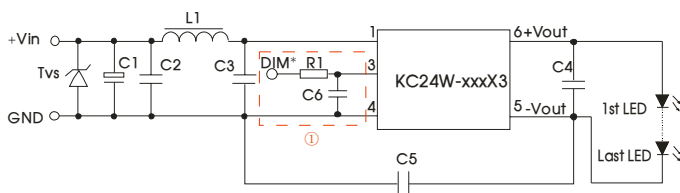

Fig.5

Comp onents	Specifications	Comp onents	Specifications
Tvs	SMC51A,1500W(Bring gtfking)	C4	105K/50V 1210 X7R (TORCH)
L1	CD53-82μH (CEAIYA)	C5	102K/2000V 1210 (TDK)(choose)
C1	470μF/100V (CapXon)	C6	470pF/100V 0805 (TORCH)
C2	225K/50V 1210 X7R (TORCH)	R1	680Ω 0805(can replaced by inductance or magnetic bead)
C3	104K/50V 0805 X7R (TORCH)	-	-

EMI/RFI conducted EN55022 Class B recommended circuit

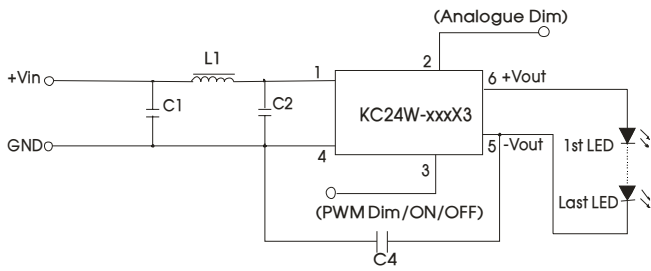
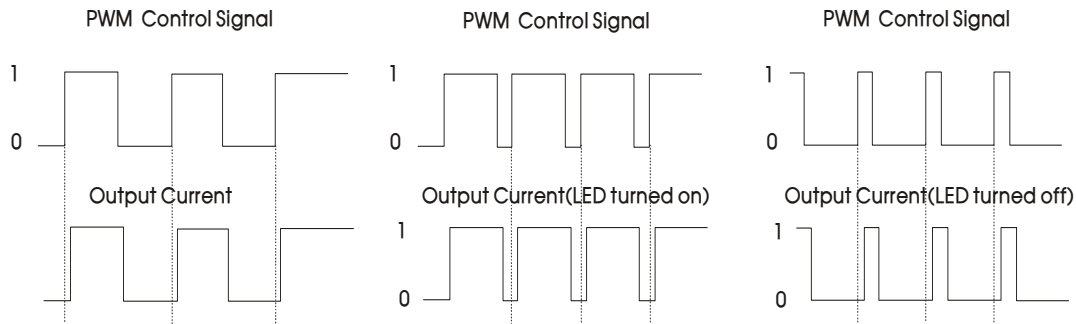

Fig. 6

Components	Specifications
C1	225K/50V 1210 x7R(TORCH)
C2, C4	104K/50V 1210 x7R(TORCH)
L1	PI043-131MT(SHENZHEN CEAIYA)

5. PWM dimming control



For PWM dimming signals with a certain frequency, the output current of the driver is related to the duty ratio of PWM signal. Refer to the formula for the calculation method:

$$I_{o_set} = \frac{(DT-0.8)}{T} I_{o_norm}$$

Where, I_{o_set} represents required output current (mA); D represents the duty ratio (%) of PWM signal; T represents the period (ms) of PWM signal; and I_{o_norm} represents the rated output value (mA) of the driver.

Note: The above formula is for reference only; and deviation of output current may exist due to various loads. The min. conducted time of PWM signal shall not be less than 0.8ms, or the product will be in abnormal operation; in case of low voice from the driver during PWM dimming, it is normal since the PWM dimming frequency is within the auditory frequency range of human ears (20Hz-20KHz in general). To prevent seeing flash of the LED by human eyes, it is suggested to set the PWM dimming frequency between 100-200Hz.

6. Analogue dimming and typical application

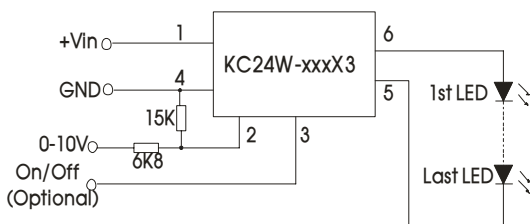

Fig. 9 Analogue dimming circuit

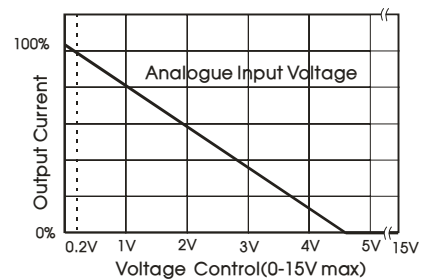

Fig. 10 Analogue input voltage and output current

7. The voltage drop of all LEDs in the datasheet is 3.3-3.8V, during actual application, the number of LEDs can be confirmed based on the actual voltage drop and output voltage of LEDs.

8. This product does not support hot-Plug use.

9. For more information please find the application notes on www.mornsun-power.com

Dimensions and Recommended Layout

THIRD ANGLE PROJECTION 

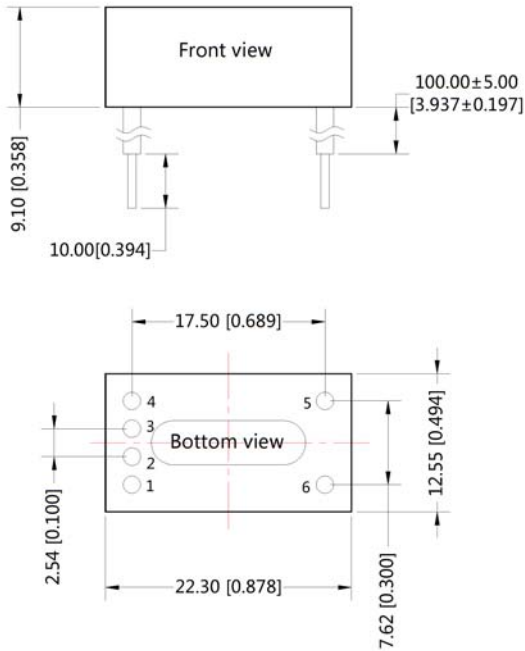

Pin	Function	Comments
1(red)	Vin	DC Supply
2(yellow)	AnalogDimming	Leave open if not use
3(white)	PWM/On/Off	Leave open if not use
4(black)	GND	Do not connect to -Vout
5(white)	-Vout	LED Cathode connection
6(yellow)	+Vout	LED Anode connection

Note:
Unit :mm[inch]
General tolerances:±0.25[±0.010]
Lead internal diameter: 0.76[0.030]
Lead external diameter: 1.60[0.063]
Lead wire spec: UL1569 300V 105°C

Notes:

1. Packing Information please refer to 'Product Packing Information'. Packing bag number: 58250002;
2. If the product is not operated within the required load range, the product performance can not be guaranteed to comply with all performance indexes in the datasheet;
3. Unless otherwise specified, data in this datasheet should be tested under the conditions of Ta=25°C, humidity<75% when inputting nominal voltage and outputting 5 LEDs;
4. All index testing methods in this datasheet are based on our Company's corporate standards;
5. The performance indexes of the product models listed in this datasheet are as above, but some indexes of non-standard model products will exceed the above-mentioned requirements, and please directly contact with our technician for specific information;
6. We can provide product customization service;
7. Specifications of this product are subject to changes without prior notice.

MORNSUN Guangzhou Science & Technology Co., Ltd.

Address: No. 5, Kehui St. 1, Kehui Development Center, Science Ave., Guangzhou Science City, Luogang District, Guangzhou, P. R. China
Tel: 86-20-38601850-8801 Fax: 86-20-38601272 E-mail: info@mornsun.cn