

1W isolated DC-DC converter with Fixed Input Voltage and Regulated Single Output

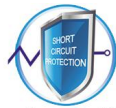

Continuous Short Circuit Protection

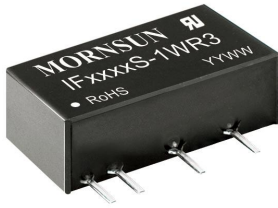

UL **CE** **CB** Patent Protection RoHS

FEATURES

- Continuous short-circuit protection
- No-load input current as low as 5mA
- Operating ambient temperature range -40°C to +85°C
- High efficiency up to 73%
- I/O isolation test voltage 3k VDC
- Industry standard pin-out
- SIP package
- UL62368/EN62368/IEC62368 Approval

IF05_S-1WR3 series are specially designed for applications where an isolated voltage is required in a distributed power supply system. They are suitable for occasions of: pre-interference isolation, ground interference elimination, pure digital circuit, voltage isolation conversion, general low frequency analog circuit, relay drive circuit, etc.

Selection Guide

Certification	Part No.	Input Voltage (VDC)	Output		Full Load Efficiency (%) Min./Typ.	Capacitive Load (µF) Max.
		Nominal (Range)	Voltage (VDC)	Current (mA) Max./Min.		
UL/CE/CB	IF0503S-1WR3	5 (4.75-5.25)	3.3	250/25	63/67	2400
	IF0505S-1WR3		5	200/20	66/70	2400
	IF0509S-1WR3		9	111/12	67/71	1000
	IF0512S-1WR3		12	84/9	68/72	560
	IF0515S-1WR3		15	67/7	69/73	560

Input Specifications

Item	Operating Conditions	Min.	Typ.	Max.	Unit
Input Current (full load / no-load)	3.3VDC/5VDC output	--	286/5	303/10	mA
	9VDC/12VDC output	--	282/12	299/20	
	15VDC output	--	274/18	290/30	
Reflected Ripple Current*		--	15	--	
Input Filter		Capacitance Filter			
Hot Plug		Unavailable			

Note: *Refer to DC-DC Converter Application Notes for detailed description of reflected ripple current test method.

Output Specifications

Item	Operating Conditions	Min.	Typ.	Max.	Unit
Output Voltage Accuracy		--	--	±3	%
Linear Regulation	Input voltage change: ±1%	--	--	±0.25	
Load Regulation	3.3VDC output, 10%-100% load	--	--	±3	
	Others, 10%-100% load			±2	
Ripple & Noise*	20MHz bandwidth	--	30	75	mVp-p
Temperature Coefficient	100% load	--	±0.02	--	%/°C
Short-circuit Protection		Continuous, self-recovery			

Note: * The "parallel cable" method is used for Ripple and Noise test, please refer to DC-DC Converter Application Notes for specific information.

General Specifications

Item	Operating Conditions	Min.	Typ.	Max.	Unit
Isolation	Input-output Electric Strength Test for 1 minute with a leakage current of 1mA max.	3000	--	--	VDC

Insulation Resistance	Input-output resistance at 500VDC	1000	--	--	MΩ	
Isolation Capacitance	Input-output capacitance at 100KHz/0.1V	--	20	--	pF	
Operating Temperature	Derating when operating temperature up to 71°C (see Fig.1)	-40	--	85	°C	
Storage Temperature		-55	--	125	°C	
Case Temperature Rise	Ta=25°C	3.3VDC output	--	30		--
		others	--	25		--
Pin Soldering Resistance Temperature	Soldering spot is 1.5mm away from case for 10 seconds	--	--	300		
Storage Humidity	Non-condensing	--	--	95	%RH	
Vibration		10-55Hz, 2G, 30Min. along X, Y and Z axis				
Switching Frequency	100% load, nominal input voltage	--	270	--	KHz	
MTBF	MIL-HDBK-217F@25°C	3500	--	--	K hours	

Mechanical Specifications

Case Material	Black plastic; flame-retardant and heat-resistant (UL94 V-0)
Dimensions	19.65 x 6.00 x 10.16mm
Weight	2.1g(Typ.)
Cooling Method	Free air convection

Electromagnetic Compatibility (EMC)

Emissions	CE	CISPR32/EN55032	CLASS B (see Fig. 3 for recommended circuit)
	RE	CISPR32/EN55032	CLASS B (see Fig. 3 for recommended circuit)
Immunity	ESD	IEC/EN61000-4-2	Air ±8kV, Contact ±4kV perf. Criteria B

Typical Characteristic Curves

Temperature Derating Curve

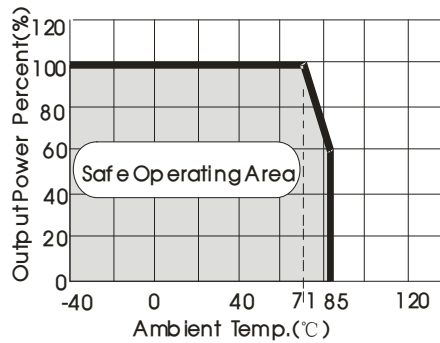
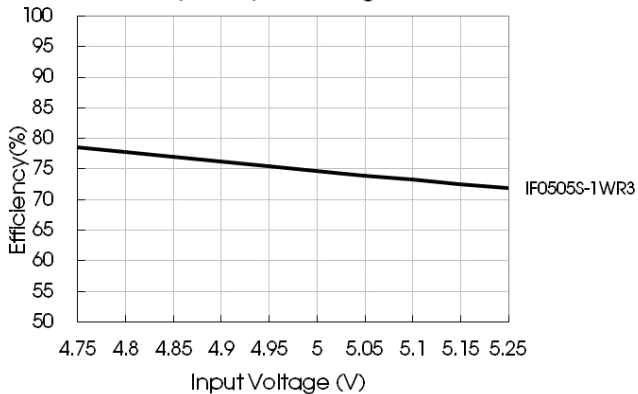
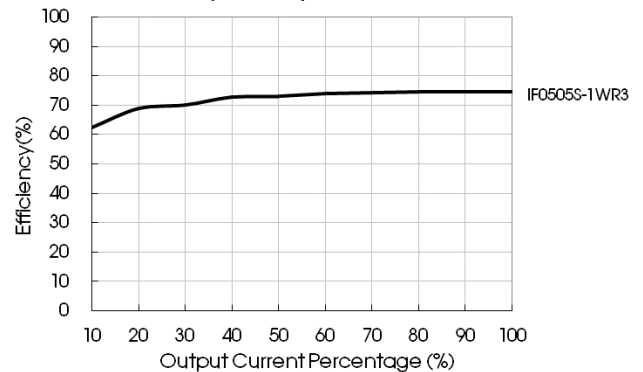

Fig. 1

Efficiency Vs Input Voltage (Full Load)



Efficiency Vs Output Load (Vin=5V)



Design Reference

1. Typical application

Input and/or output ripple can be further reduced, by connecting a filter capacitor from the input and/or output terminals to ground as shown in Fig.2.

Choosing suitable filter capacitor values is very important for a smooth operation of the modules, particularly to avoid start-up problems caused by capacitor values that are too high. For recommended input and output capacitor values refer to Table 1.

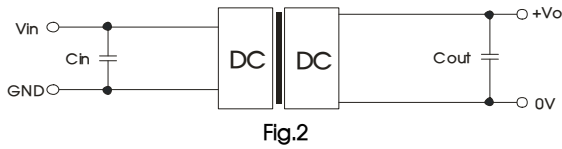

Table 1: Recommended input and output capacitor values

$V_{in}(VDC)$	$C_{in}(\mu F)$	$V_o (VDC)$	$C_{out}(\mu F)$
5	4.7	3.3/5	10
--	--	9/12	2.2
--	--	15	1

2. EMC compliance circuit

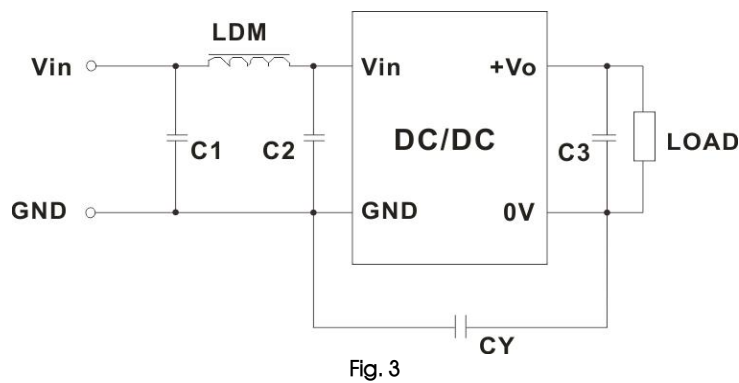
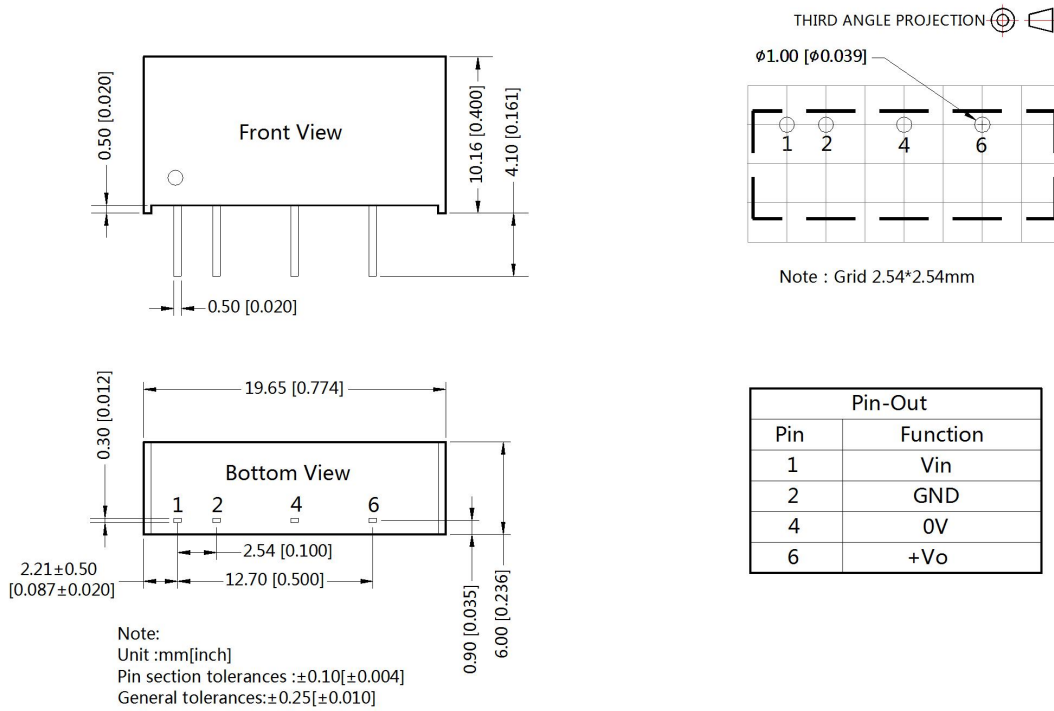

Table 2: Recommended EMC filter values

Input voltage 5VDC	Output voltage (VDC)	3.3/5/9	12/15
		EMI	C_1/C_2
		CY	--
		C3	Refer to the C_{out} in table 1
		LDM	6.8 μH
			1nF/4kVDC VISHAY HGZ102MBP TDK CD45-E2GA102M-GKA

3. For additional information please refer to DC-DC converter application notes on www.mornsun-power.com

Dimensions and Recommended Layout



Notes:

- For additional information on Product Packaging please refer to www.mornsun-power.com. packaging bag number 58200001;
- If the product is not operated within the required load range, the product performance cannot be guaranteed to comply with all parameters in the datasheet;
- The maximum capacitive load offered were tested at input voltage range and full load;
- Unless otherwise specified, parameters in this datasheet were measured under the conditions of Ta=25°C, humidity<75%RH with nominal input voltage and rated output load;
- All index testing methods in this datasheet are based on our Company's corporate standards;
- We can provide product customization service, please contact our technicians directly for specific information;
- Products are related to laws and regulations: see "Features" and "EMC";
- Our products shall be classified according to ISO14001 and related environmental laws and regulations, and shall be handled by qualified units.

MORNSUN Guangzhou Science & Technology Co., Ltd.

Address: No. 5, Kehui St. 1, Kehui Development Center, Science Ave., Guangzhou Science City, Luogang District, Guangzhou, P. R. China
Tel: 86-20-38601850 Fax: 86-20-38601272 E-mail: sales@mornsun.cn www.mornsun-power.com