

EV Charger Residual Current Transducer  
TLB6-A1SVE



RoHS



## Features

- Open-loop, fluxgate-based current transducer
- Meet IEC 62752: 2018 (IC-CPD)
- Meet IEC 62955: 2018 (RDC-PD)
- Meet the requirements of AC 30mA and DC 6mA residual current detection
- PCB installation, small size, easy for using
- 5,000 A surge current capability

TLB6-A1SVE is a residual current transducer for EV charger. It can be widely used in the electric vehicle charger industry. It uses fluxgate detection technology to detect DC, AC, and various pulsating residual currents. The module meets the residual current requirements of IEC62752 (mode 2) and IEC62955 (mode 3) testing standards. It can detect residual current waveform covering Type B, and can detect 6mA DC residual current. The trigger is sensitive and responds to leakage events in time.

## Selection Guide

Part No.	Input Voltage	Rated DC Residual Current	Rated AC Residual Current	Rated Current	Maximum Power Dissipation
TLB6-A1SVE	5VDC	6mA	30mA	40A	0.25W

## Electrical Characteristics

Item	Symbol	Min	Typ	Max	Unit.
Rated Residual DC Operating Current	$I_{\Delta NDC}$	--	6	--	mA
Rated Residual AC Operating Current	$I_{\Delta NAC}$	--	30	--	mA
Range of Remaining DC Operating Current	$I_{\Delta NDC-RANGE}$	3	4.5	6	mA
Range of Remaining AC Operating Current	$I_{\Delta NAC-RANGE}$	15	24	30	mA
Input Voltage	$V_{CC}$	4.85	5	5.15	V
Operating Current	--	--	25	50	mA

## Protection and Detection Characteristics

Item	Symbol	Min	Typ	Max	Unit.
Self Check Input Low Level Voltage	$V_{TEST-IL}$	0	--	1	V
Self Check Input High Level Voltage	$V_{TEST-IH}$	3	--	5.1	V
Calibration Input Low Voltage	$V_{CAL-IL}$	0	--	1	V
Calibration Input High Voltage	$V_{CAL-IH}$	4	--	5.1	V
Operating Output Low Level Voltage	$V_{TRIP-OL}$	0	--	0.6	V
Operating Output High Level Voltage	$V_{TRIP-OH}$	4.5	--	5.15	V

## General Characteristics

Item	Symbol	Min	Typ	Max	Unit.
Operating Temperature	$T_a$	-40	--	+85	°C
Storage Temperature	$T_s$	-40	--	+125	°C
Weight	m	14	17	20	g
Vibration		0-150Hz, 5g (GB2423.10, IEC60068-2-6)			
Overvoltage Category		OVC III (IEC61010)			

**Performance Characteristic**

Item	Symbol	Residual Current Waveform	Min	Typ	Max	Unit.
Residual Operating Current	$I_{\Delta NAC50}$	Frequency 50Hz AC	15	22.5	30	mA RMS
	$I_{\Delta NA0}$	0 Angle Pulsating DC	11	15	30	mA RMS
	$I_{\Delta NA90}$	90 Angle Pulsating DC	10	15	30	mA RMS
	$I_{\Delta NA135}$	135 Angle Pulsating DC	10	15	35	mA RMS
	$I_{\Delta NS-DC}$	Smooth DC	3	4.5	6	mA RMS
	$I_{\Delta N2PDC}$	Two Phase Rectification DC	3.5	5	7	mA RMS
	$I_{\Delta N3PDC}$	Three Phase Rectification DC	3.1	4.5	6.2	mA RMS
	$I_{\Delta NF}$	Composite Current	18	28	38	mA RMS
Response Time	$T_{\Delta NAC50@30mA}$	RMS 30mA Frequency 50Hz AC	--	40	60	ms
	$T_{\Delta NAC50@60mA}$	RMS 60mA Frequency 50Hz AC	--	30	60	ms
	$T_{\Delta NAC50@150mA}$	RMS 150mA Frequency 50Hz AC	--	15	40	ms
	$T_{\Delta NA0@42mA}$	RMS 42mA 0 Angle Pulsating DC	--	38	50	ms
	$T_{\Delta NA0@84mA}$	RMS 84mA 0 Angle Pulsating DC	--	30	40	ms
	$T_{\Delta NA0@210mA}$	RMS 210mA 0 Angle Pulsating DC	--	25	35	ms
	$T_{\Delta NA0@42mA+S-DC@6mA}$	RMS 42mA 0 Angle Pulsating DC with 6mA Smooth DC	--	38	50	ms
	$T_{\Delta NA0@84mA+S-DC@6mA}$	RMS 84mA 0 Angle Pulsating DC with 6mA Smooth DC	--	30	40	ms
	$T_{\Delta NA0@210mA+S-DC@6mA}$	RMS 210mA 0 Angle Pulsating DC with 6mA Smooth DC	--	25	35	ms
	$T_{\Delta NS-DC@6mA}$	6mA Smooth DC	--	140	200	ms
	$T_{\Delta NS-DC@60mA}$	60mA Smooth DC	--	25	60	ms
	$T_{\Delta NS-DC@300mA}$	300mA Smooth DC	--	25	30	ms
	$T_{\Delta N2PDC@6mA}$	RMS 6mA Two Phase Rectification DC	--	140	200	ms
	$T_{\Delta N2PDC@60mA}$	RMS 60mA Two Phase Rectification DC	--	25	60	ms
	$T_{\Delta N2PDC@300mA}$	RMS 300mA Two Phase Rectification DC	--	25	30	ms
	$T_{\Delta N3PDC@6mA}$	RMS 6mA Three Phase Rectification DC	--	140	200	ms
	$T_{\Delta N3PDC@60mA}$	RMS 60mA Three Phase Rectification DC	--	25	60	ms
	$T_{\Delta N3PDC@300mA}$	RMS 300mA Three Phase Rectification DC	--	25	30	ms
$T_{\Delta NF@210mA}$	RMS 210mA Composite Current	--	15	35	ms	

**Isolation Characteristics**

Item	Operating Conditions	Min	Typ	Max	Unit.
Isolation Voltage	Primary edge input, secondary output; 50Hz,1min; leakage current<1mA	--	--	3	kVAC
Insulation Resistance	500VDC	1	--	--	GΩ
Pulse Withstand Voltage	1.2/50μs	--	7	--	kV

**EMC**

Item	Specifications				
EMI	CE	CISPR32/EN55032 CLASS B			
	RE	CISPR32/EN55032 CLASS B			
EMS	ESD	IEC/EN61000-4-2 Contact ±4kV, Air ±8kV			perf. Criteria A
	RS	IEC/EN61000-4-3 10V/m			perf. Criteria A
	Surge Current	IEC62955 5000A, 8/20us			perf. Criteria A

Product Characteristic Curve

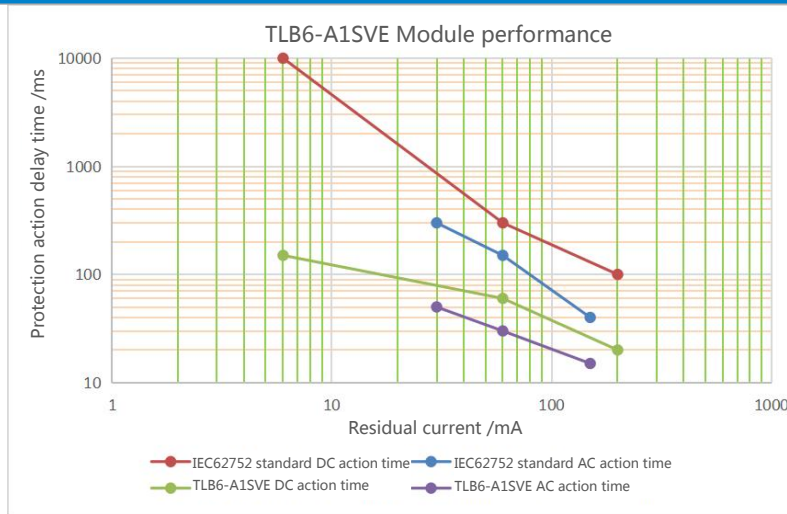

Pin Description

Pin	Mark	Description
2	CAL	Zero calibration pin, when the pin inputs a duration >50ms and <100ms low voltage, the calibration function is enabled and the residual current detected at the moment is used as the zero current point of the residual current compensated for subsequent detection. This residual current compensation value is stored internally and continues to be compensated upon reboot.
3	TEST	Test pin, when the pin input high level, there will be a built-in residual current, making the action signal action. It can be designed for periodic self-test of products.
4	VCC	The product is powered by VCC, which needs to supply 5V, and 100nF and 1uF capacitors are connected in parallel at the input end.
5	GND	Product-powered ground.
6	TRIP	Trip output pin, when detected > 6mA DC residual current or > 30mA AC residual current, the pin is set high and a trip signal is generated.
7-10	--	For primary wires connection.
1	NC	Not connected.

Connection and Description

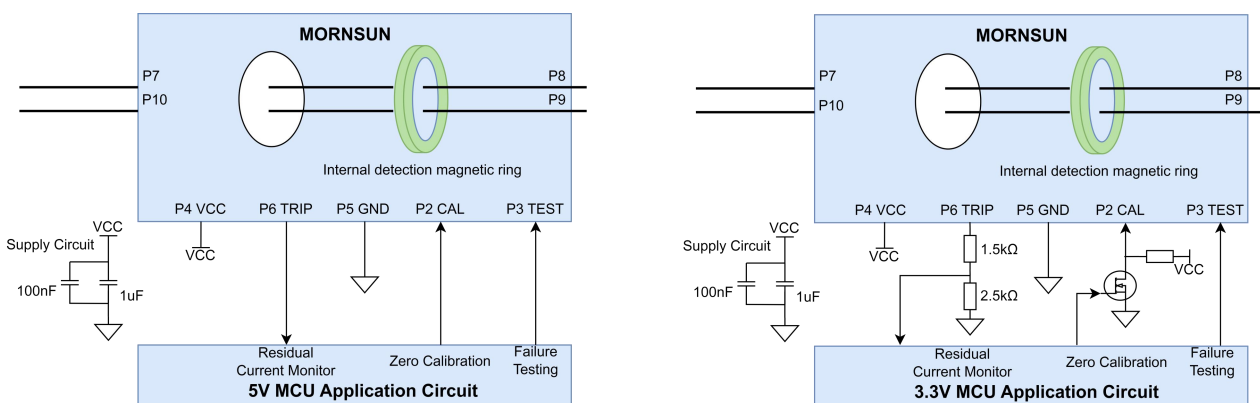

- Two capacitors 1uF/16V and 100nF/16V need to be provided at VCC and GND for energy storage and decoupling.
- Zero calibration pin CAL, and TEST pin are generally controlled by a microcontroller.
- The trip output pin TRIP is connected to the microcontroller, the trip output pin will output high level when the current value flowing through the internal detection magnetic ring exceeds the specification value.
- When the module is started, the zero calibration pin should be kept at a low level for a period of time and then placed at a high level.

See the timing sequence characteristic description.

- TEST is used to test the performance of residual current transducer when self-test is required, and the test signal needs to meet the timing characteristics.
- Hot plug is unavailable.
- The product is connected to 5V MCU for use, and it is necessary to pay attention to level matching. If a 3.3V MCU is connected, a level conversion circuit is required for voltage conversion (as shown in the figure above). The 5V voltage is converted to 3.3V by two resistors, and the ratio of the two resistors is generally selected to be close to 3:5. At the same time, the input impedance of the MCU should be considered, and the resistance value of the two voltages should not be greater than one-tenth of the input impedance of the MCU. For example, the values of the two resistors are 1.5kΩ and 2.5kΩ or 10kΩ and 15kΩ. In addition, the zero calibration function needs to adjust the timing. For example, the zero calibration function of the product is effective at a low level. After connecting the MOS for level conversion, the 3.3V MCU should output a high level to make the calibration function effective, and the 3.3V MCU should output a low level when the product is not calibrated.

### Timing Characteristics

Item	Symbol	Min	Typ	Max	Unit.
Start To Calibration Interval	T1	600	--	--	ms
Calibrate Signal Maintenance Time	T2	50	--	100	ms
Calibration Signal Completion Wait Time	T3	--	500	--	ms
Test Signal Duration	T4	--	--	200	ms

### Timing Application Design

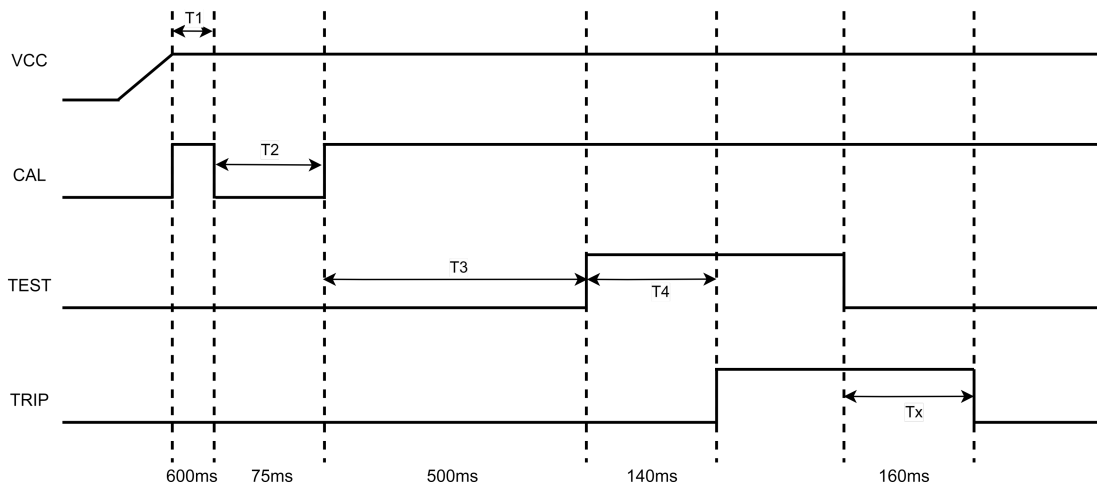

Timing application design essentials:

- After the power supply is fully started, the start-up and stabilization time of the module is about 200-300ms. The zero calibration delay time T1 must be greater than 100ms.
- The zero calibration signal duration T2 must be greater than 50ms and less than 100ms; When the CAL low time is greater than 50ms, TLB6-A1SVE starts to zero calibration.
- After the completion of calibration, the calibration stabilization time is about 200-250ms. It is required to wait for the calibration completion time T3 to be greater than 500ms.
- It is required to wait until T3 is completed to enable the TEST signal. After the TEST signal is applied for about 100-140ms (T4), TRIP is set to high.
- After TRIP is set to high, TEST can be set to low at any time, turn off the TEST signal, and then after Tx=150-250ms, TRIP pin high level returns to low level.

Dimensions and Recommended

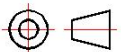
THIRD ANGLE PROJECTION 

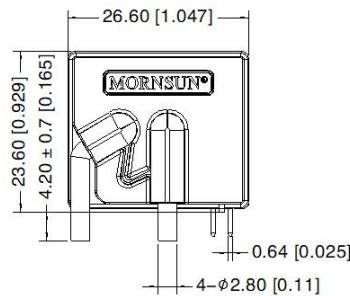

Front View

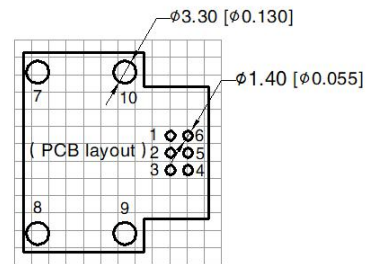

Note: Grid 2.54\*2.54mm

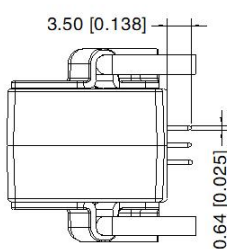

Left View

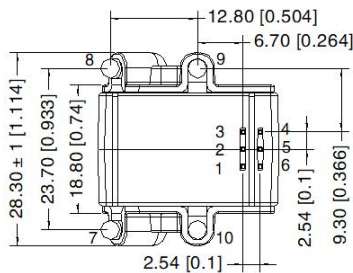

Bottom View

Pin-Out	
Pin	Mark
1	NC
2	CAL
3	TEST
4	VCC
5	GND
6	TRIP
7-10	For primary wires connection

Note:  
Unit: mm[inch]  
Pin diameter tolerances:  $\pm 0.10[\pm 0.004]$   
General tolerances:  $\pm 0.50[\pm 0.02]$

The layout of the device is for reference only, please refer to the actual product

Notes:

- For additional information on Product Packaging please refer to [www.mornsun-power.com](http://www.mornsun-power.com). Packaging bag number: 58070013;
- All index testing methods in this datasheet are based on company corporate standards;
- Unless otherwise specified, parameters in this datasheet were measured under the conditions of  $T_a=25^\circ\text{C}$ , humidity<75%RH with nominal input voltage;
- We can provide product customization service, please contact our technicians directly for specific information;
- This products is used in electronic equipment, please follow the operation and instructions of the manual, and use it in a standard and safe environment;
- Please do not install the product in a dangerous area; beware of the risk of electric shock during operating, some modules may generate dangerous voltages (such as primary wires, power supply wires);
- This products is a build-in device, After installation, the conductive part must not be touched completely. A protective box or shield can be used;
- It is strictly forbidden to disassemble and assemble the products privately to prevent equipment without failure or malfunction;
- Our products shall be classified according to ISO14001 and related environmental laws and regulations, and shall be handled by qualified units.

Mornsun Guangzhou Science & Technology Co., Ltd.

Address: No. 5, Kehui St. 1, Kehui Development Center, Science Ave., Guangzhou Science City, Huangpu District, Huangpu, P. R. China

Tel: 86-20-38601850

Fax: 86-20-38601272

E-mail: [info@mornsun.cn](mailto:info@mornsun.cn)

[www.mornsun-power.com](http://www.mornsun-power.com)