

TD541S485H-S DFN package isolated RS485 Transceiver

Features

- Ultra-small, ultra-thin, chip scale DFN package
- Compliant with TIA/EIA-485-A standard
- Integrated isolated 5V power
- I/O power supply range supports 3.3V and 5V microprocessors(RXD can be directly connected when using 5V microprocessor; When using 3.3V microprocessor, please refer to point 5 in “Suggestions for Power Supply”.)
- High isolation to 5000VDC
- Bus-Pin ESD protection up to 15kV(HBM)
- Baud rate up to 10Mbps
- >25kV/us CMTI
- Low communication delay
- 1/8 unit load—up to 256 nodes on a bus
- Bus fail-safe
- Bus driver short circuit protection
- Industrial operating ambient temperature range: -40°C to +105°C
- AEC-Q100 experiment in progress
- EN62368 approval
- Moisture Sensitivity Level (MSL) 3
- Bottom PCB meets CTI Category II ($400 \leq \text{CTI} < 600$)

Package

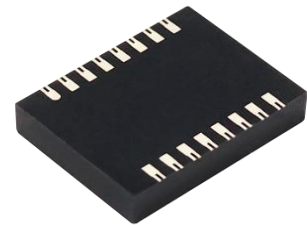

Applications

- Industrial Automation
- Building Automation
- Smart Electricity Meter
- Remote Signal Interaction, Transmission

Functional Description

TD541S485H-S is a half-duplex enhanced transceiver designed for RS-485 data bus networks, which is fully compliant with TIA/EIA-485-A standard and is suitable for data transmission of up to 10 Mbps. Their logic side supports 3.3V and 5V logic level conversion. Receivers have an exceptionally high input impedance, which places only 1/8 of the standard load on a shared bus and up to 256 transceivers.

The reliability design of A and B pin is emphasized, including driver output over current protection and enhanced ESD design. The ESD protection level of A, B pin can be up to 15KV (Human Body Model).

Contents

1	Home.....	1	5	Characteristic Curve.....	5
1.1	Feature and Package.....	1	5.1	Typical Performance Curve.....	5
1.2	Applications.....	1	5.2	Parameter Measurement Information.....	5
1.3	Functional Description.....	1	6	Product working Description.....	6
2	Pin Package and internal block diagram.....	2	7	Application Circuit.....	7
3	Truth table.....	2	8	Suggestions for Power Supply.....	7
4	IC Related Parameters.....	3	9	Order Information.....	8
4.1	Absolute Maximum Rating.....	3	10	Package Information.....	9
4.2	Recommended Operating Conditions.....	3	11	Tape & Reel Information.....	10
4.3	Electrical Characteristics.....	4			
4.4	Transmission Characteristics.....	5			
4.5	Physical Characteristics.....	5			

Pin Connection

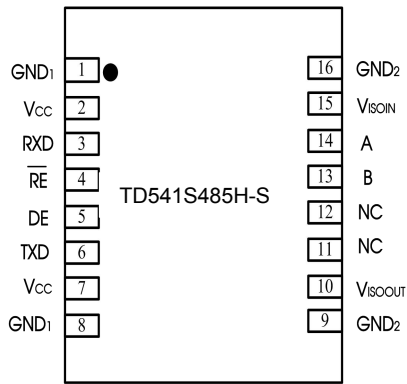

Note: All GND1 pins are internally connected.
All GND2 pins are internally connected.

Internal Block

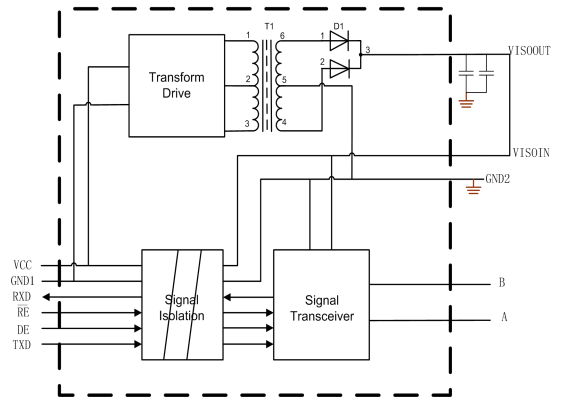

Function Table

Letter	Description
H	High-Level
L	Low-Level
X	Unrelated
Z	High Impedance

Table 1. Driver Function table

TXD	DE	Output	
		A	B
H	H	H	L
L	H	L	H
X	L	Z	Z
OPEN	H	H	L

Table 2. Receiver Function table

Difference input $V_{ID} = (V_A - V_B)$	\overline{RE}	RXD
$-0.02\text{ V} \leq V_{ID}$	L	H
$-0.22\text{ V} < V_{ID} < -0.02\text{ V}$	L	Uncertainty
$V_{ID} \leq -0.22\text{ V}$	L	L
Open circuit	L	H
Short circuit	L	H

Pin Descriptions

Pin Number	Pin Name	Pin Functions
1	GND ₁	Ground(Logic side).
2	V _{CC}	Power supply. By using 0.1uF ceramic capacitance ground(GND1).
3	RXD	Receiver output pin.
4	\overline{RE}	Receiver enable input. When \overline{RE} is low, if (A - B) ≥ -20 mV, then RXD = high. if (A - B) ≤ -220 mV, then RXD = low.
5	DE	Driver enable input. When DE is high, outputs are enabled. When DE is low, outputs are high impedance. Drive DE low and \overline{RE} high to enter shutdown mode.
6	TXD	Driver input pin.
7	V _{CC}	Power supply. By using 1uF ceramic capacitance ground(GND1).
8	GND ₁	Ground(Logic side).
9	GND ₂	Ground (Bus Side).
10	V _{ISOOUT}	Insulation power output. By using 1uF Ceramic capacitance ground(GND2, pin9). The pin needs to be connected to pin15 in application.
11	NC	No Connect.
12	NC	No Connect.
13	B	RS485 Bus B Line.
14	A	RS485 Bus A Line.
15	V _{ISOIN}	Insulation power input. By using 0.1uF ceramic capacitance ground(GND2, pin16). The pin needs to be connected to pin10 in application.
16	GND ₂	Ground (Bus Side).

Absolute Maximum Ratings

General test conditions: Free-air, normal operating temperature range (Unless otherwise specified).

Parameters	Unit
Supply voltage	-0.3V to +6V
Bus voltage	-8V to+13V
Digital Input Voltage (DE, \overline{RE} , TXD, RXD)	-0.3V to+6V
Operating Temperature Range	-40°C to +105°C
Storage Temperature Range	-50°C to +105°C
Reflow Soldering Temperature	Peak temp. ≤250°C, maximum duration ≤60s at 217°C. Please also refer to IPC/JEDEC J-STD-020D. 3.

Important: Exposure to absolute maximum rated conditions for an extended period may severely affect the device reliability, and stress levels exceeding the "Absolute Maximum Ratings" may result in permanent damage.

Recommended Operating Conditions

Symbol	Recommend an operate condition	Min.	Typ.	Max.	Unit
V _{CC}	Supply voltage	4.5	5	5.5	V
V _I	Voltage at any bus terminal (differential or common mode)	-7		12	
V _{IH}	High-level input voltage(TXD, DE, \overline{RE})	2		V _{CC}	
V _{IL}	Low-level input voltage(TXD, DE, \overline{RE})	0		0.8	
I _{OS}	Output current	Driver	-60	60	mA
		Receiver	-8	8	
R _{IN}	Differential output load resistance	54	60		Ω
T _A	Operating temperature range	-40		105	°C
-	Signaling rate			1000	kbps

Symbol	Parameter	Conditions	Min.	Typ.	Max.	Unit	
Driver							
V _{OD}	Differential driver output	No load	3.5			V	
		R _L =54Ω, Figure 7	1.5	2.0		V	
		R _L =100Ω, Figure 7	2.0			V	
ΔV _{OD}	Δ V _{OD} for complementary output states	R _L =54Ω, Figure 7			±0.2	V	
V _{OC}	Common-Mode output voltage	Figure 6	1		3	V	
ΔV _{OC(SS)}	Δ V _{OC} for complementary output states	Figure 6	-0.1		0.1	V	
I _{OS}	Output short-circuit current	-7V ≤ V _A or V _B ≤ +12V		±110	±250	mA	
R _{TXD}	Internal TXD Pull up Resistor			5.1		kΩ	
R _{DE}	Internal DE Pull down Resistor			5.1		kΩ	
Receiver							
V _{IT(+)}	Positive differential input threshold voltage	-7 V ≤ V _A or V _B ≤ +12 V			-20	mV	
V _{IT(-)}	Negative differential input threshold voltage	-7 V ≤ V _A or V _B ≤ +12 V	-220			mV	
V _{hys}	Hysteresis voltage (V _{IT+} - V _{IT-})	-7 V ≤ V _A or V _B ≤ +12 V		20		mV	
R _{ID}	Differential input resistance(A, B)	-7 V ≤ V _A or V _B ≤ +12 V	96			kΩ	
I _I	Input current (A, B)	DE=0, \overline{RE} =0, V _{CC} =0 or 5.5V	V _{OUT} =12V		190	250	uA
			V _{OUT} = -7V	-200	-110		uA
V _{OH}	RXD output high voltage	I _{OUT} = 20 μA, V _A - V _B = 0.2 V	V _{CC} - 0.1			V	
		I _{OUT} = 4 mA, V _A - V _B = 0.2 V	V _{CC} - 0.4	V _{CC} - 0.2		V	
V _{OL}	RXD output low voltage	I _{OUT} = -20 μA, V _A - V _B = -0.2 V			0.1	V	
		I _{OUT} = -4 mA, V _A - V _B = -0.2 V			0.4	V	
Power supply and protection characteristic							
I _{CC}	Supply current	DE= \overline{RE} =0V		15	30	mA	
I _{CC}	Working current	Between A, B 100Ω load		60	80	mA	
		Between A, B 54Ω load		75	105	mA	
ESD	HBM	A, B to GND			±15	kV	
		Other pin			±2	kV	
EFT	IEC61000-4-4	A, B and GND			±2	kV	
SURGE	IEC61000-4-5	A, B and GND(Common Mode)			±2	kV	
VI-O	Insulate voltage	TD541S485H-S			5000	VDC	
	Insulate impedance		1			GΩ	
	Insulate capacitance			3		pF	
CMTI	Common mode transient immunity	TXD = V _{CC} or 0 V, V _{CM} = 1 kV, transient magnitude = 800 V	25			kV/us	

Transmission Characteristics

Symbol	Parameter	Conditions	Min.	Typ.	Max.	Unit
-	Maximum data rate	Duty 40% ~ 60%			1000	kbps
T_{PHL}, T_{PLH}	Driver propagation delay	$R_L = 54\Omega, C_L = 50pF$, Figure 8		100	200	ns
$ T_{PHL}-T_{PLH} $	Driver skew ($ T_{PHL} - T_{PLH} $)			30	100	ns
T_R, T_F	Driver rise/fall time		30	50	100	ns
T_{PHL}, T_{PLH}	Receiver propagation delay	$C_L = 15pF$ Figure 9		50	150	ns
$ T_{PHL}-T_{PLH} $	Receiver skew ($ T_{PLH} - T_{PHL} $)			15	50	ns
T_R, T_F	Receiver rise/fall time		$C_L = 15pF$ Figure 9		15	

Physical Specifications

Parameters	Value	Unit
Weight	0.8(Typ.)	g

Typical Performance Curves

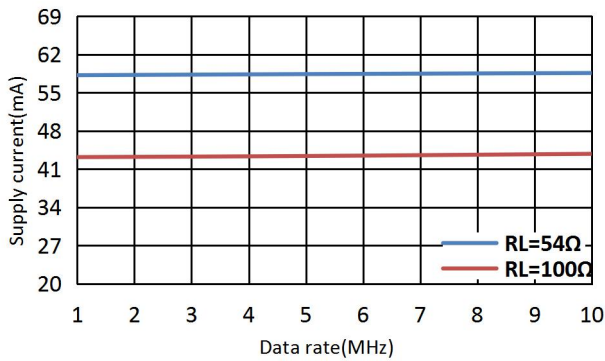

Figure 1. Supply current vs. Data rate

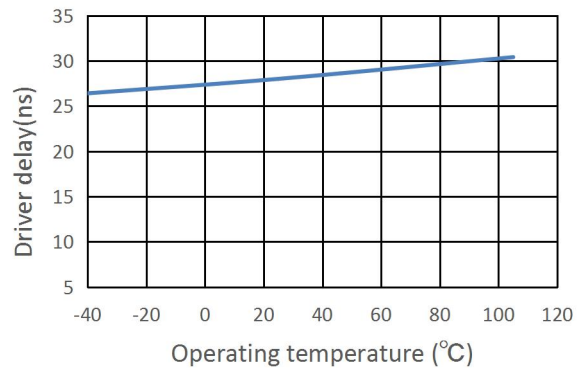

Figure 2. Driver delay vs. Operating Temperature

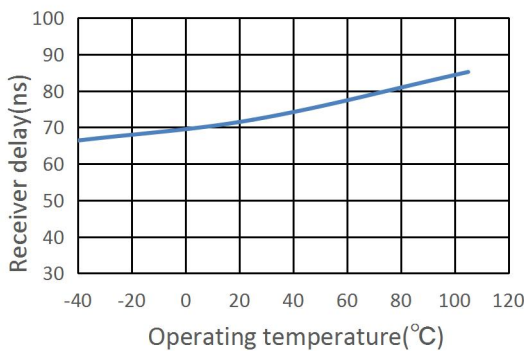

Figure 3. Receiver delay vs. Operating Temperature

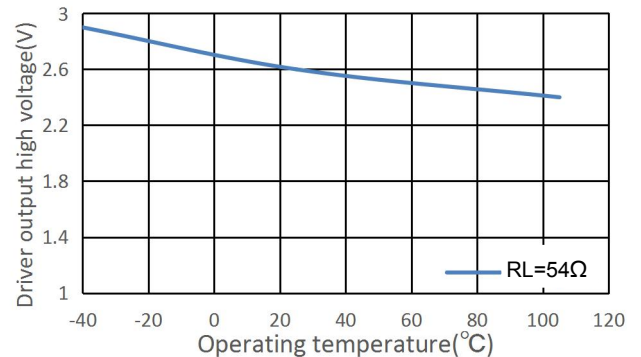

Figure 4. Driver output high voltage vs. Operating Temperature

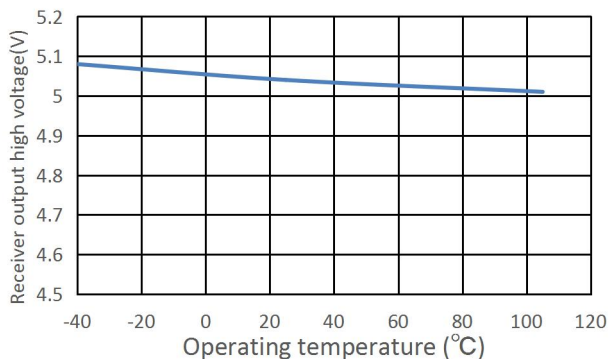

Figure 5. Receiver output high voltage vs. Operating Temperature

Test Circuits

Note: Testing the condition burden capacitance including test to stretch forward and testing fixture parasitic capacitance. Testing semaphore upswing and droop to follow < 6ns. frequency 10MHz. duty50%. resistance $Z_O = 54\Omega$.

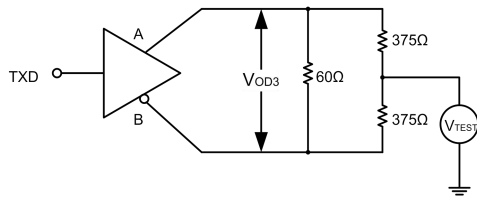

Figure 6. Driver test circuit, VOD with common-mode loading

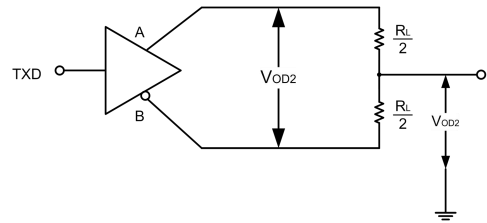

Figure 7. Driver test circuit

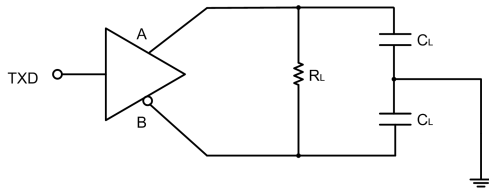

Figure 8. Drive propagation delay test circuit and wave forms

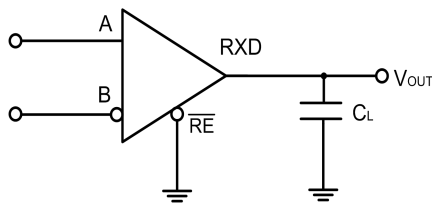
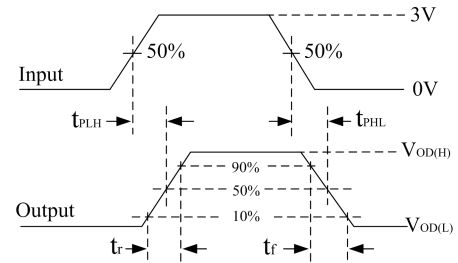
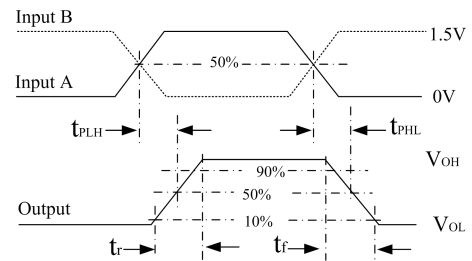

Figure 9. Receiver propagation delay test circuit and wave forms



Detailed Description

TD541S485H-S is a semi-duplex enhanced RS485 isolated transceiver with isolated power supply. In addition to an isolated power supply, each transceiver contains a drive and a receiver. The transceiver has a standby bus failure protection function to ensure that the receiver output is high when the receiver input is open, short, or when the bus is idle. TD541S485H-S adopts 5VDC single power supply. The whole machine can monitor the overall working state of the module and limit the output high current, so as to prevent the bus overload or short circuit from causing non-recoverable damage to the transceiver.

Receiver input filter: TD541S485H-S receiver integrated high performance input filter, the filter can greatly enhance the receiver's noise suppression ability to high speed differential signal. Therefore, the transmission delay of the receiver is also caused by this reason.

Bus failure protection: In general, when $-220\text{mV} < A - B < -20\text{mV}$, the bus receiver will be in an indeterminate state. This phenomenon occurs when the bus is idle. Bus failure protection ensures that the receiver outputs a high level when the receiver input is open, short, or when the bus access port matches the resistance. TD541S485H-S receiver threshold voltage is relatively accurate, and the threshold voltage to the reference ground has a margin of at least 10mV, which can ensure that even if the bus differential voltage is 0V, the receiver output level is high, and meets the requirements of EIA/TIA-485 standard $\pm 200\text{mV}$.

The bus load capacity (256 point): standard RS485 receiver input impedance is defined as 12 k Ω (unit load). A standard RS485 driver can drive at least 32 load units. TD541S485H-S bus receiver designed by 1/8 unit load, the input impedance is greater than 96 k Ω . As a result, the bus allows access to more transceivers (up to 256). TD541S485H-S can also be mixed with the standard RS485 transceiver with 32 unit loads (cumulative receiver load cannot exceed 32 units).

Low power SHUTDOWN mode: When high level is input and low power is input, the transceiver enters SHUTDOWN mode. When the transceiver enters off mode, its overall standby power consumption decreases, DE can be short-connected and controlled by the same I/O. If the high level is input and the holding time of DE low level is less than 50ns, the transceiver cannot enter the off mode. If the holding time can be maintained at least 600ns, the transceiver will reliably enter the off mode.

Drive output protection: TD541S485H-S internal integrated drive short circuit (or overcurrent) protection module. In case of bus error or driver short circuit, the module can limit the output current of the driver within a certain limit.

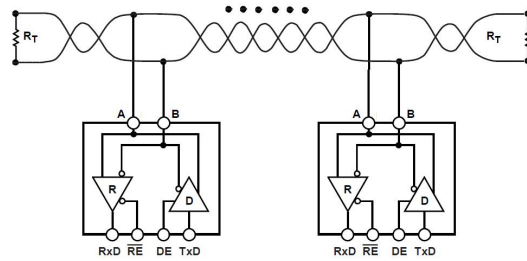

Figure10. Typical application circuit (half-duplex network topology) VISIO

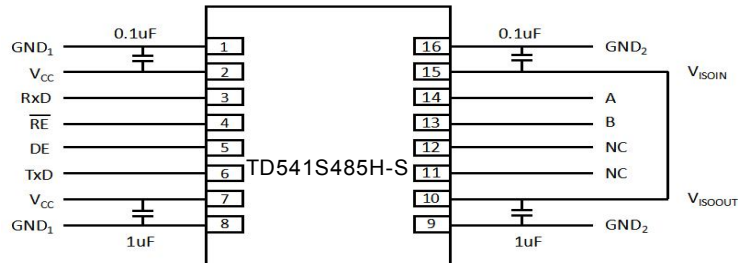

Figure11. Type PCB layout

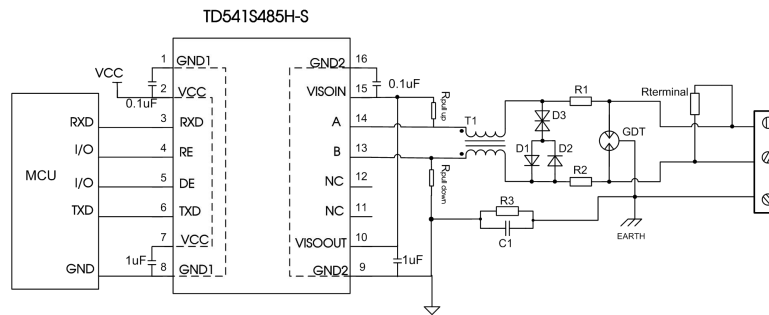

Figure12. Port protection circuit for harsh environments

Recommended components and values:

Component	Recommended part, value	Component	Recommended part, value
R3	1MΩ	R1, R2	2.7Ω/2W
C1	1nF, 2kV	D1, D2	1N4007
T1	ACM2520-301-2P	D3	SMBJ8.5CA
GDT	B3D090L	R _{terminal}	120 Ω

As the modules internal A / B lines come with its own ESD protection, which generally satisfy most application environments without the need for additional ESD protection devices. For harsh and noisy application environments such as motors, high voltage/current switches, lightning and similar however, we recommended that the user protects the modules A/B lines with additional measures and external components such as TVS tube, common mode inductors, Gas discharge tube, shielded twisted pair of wires with the same single network Earth point. Figure 12 shows our recommended circuit diagram for such type of applications with components and values given in the table above. This recommendation is for reference only and may have to be adapted accordingly with appropriate component values in order to match the actual situation and application.

Note: Select the R_{terminal} according to the actual application.

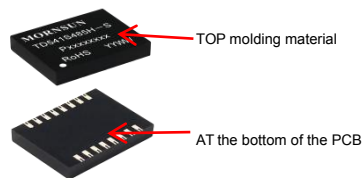

The top molding material of the product meets CTI category I (600≤CTI); Bottom PCB plate meets CTI category II (400≤CTI<600).

Using Suggests

- ① Power isolation V_{ISOOUT} need through a series of capacitors connected to the output pin V_{ISOIN} , in addition to the mentioned in ④ of the pull up and down function, the power supply is not recommended for other purposes, otherwise it may cause the bus voltage did not meet the requirements of communication, causes the communication failure.
- ② DE and \overline{RE} pin do not support dangling. If the pin is not access controller, the recommended by $30k\Omega$ pulldown resistor pins connect to GND. Keep the node in the receiving state only, not affect the bus.
- ③ DE, \overline{RE} , TXD pin is always not allow to set to open drain output state connect the controller, otherwise it will lead to uncertain consequences.
- ④ To maintain A - B bus idle stability, we need at least one node will pull up A to V_{ISOIN} and drop down B to GND₂ on the bus. Overall network at the same time pull up and drop down resistance of the parallel value must around 380Ω to $420\Omega(0.2W)$.

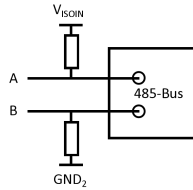

Figure13. Pull up and drop down resistance connect

- ⑤ The output of TD541S485H-S to RXD is only compatible with 5V system, if the I/O port is 3.3V level and does not support 5V input, please refer to the following recommended circuit :

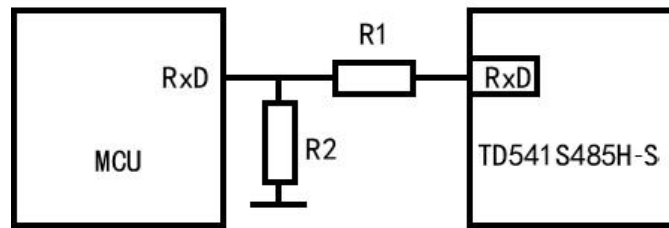

Figure14. Match MCU system connection

The calculation formula of resistance partial voltage of conventional step-down-circuit is

$$R1 = \frac{V_{out} - V_{in}}{V_{in}} R2$$

Where R1,R2 is piezoelectric resistance value of the connected part, V_{out} is TD541S485H-S output voltage, V_{in} is MCU RXD input voltage. The recommended value is $R1=1k\Omega$, $R2=2k\Omega$.

- ⑥ Hot-swap is not supported.
- ⑦ If the external input of TXD is insufficient, the pull-up resistor should be added according to the situation.
- ⑧ Refer to IPC 7093 for the welding process design of this product. For detailed operation guidance, please refer to *Hot Air Gun Welding Operation Instruction for DFN Package Product* or *Welding Operation Instruction for DFN Package Product*.

Ordering Information

Part number	Package	Number of pins	Product marking	Tape & Reel
TD541S485H-S	DFN	16	TD541S485H-S	300/REEL

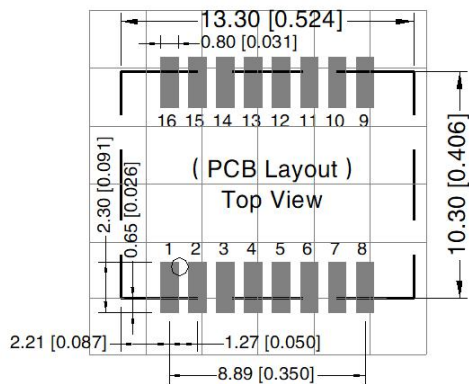
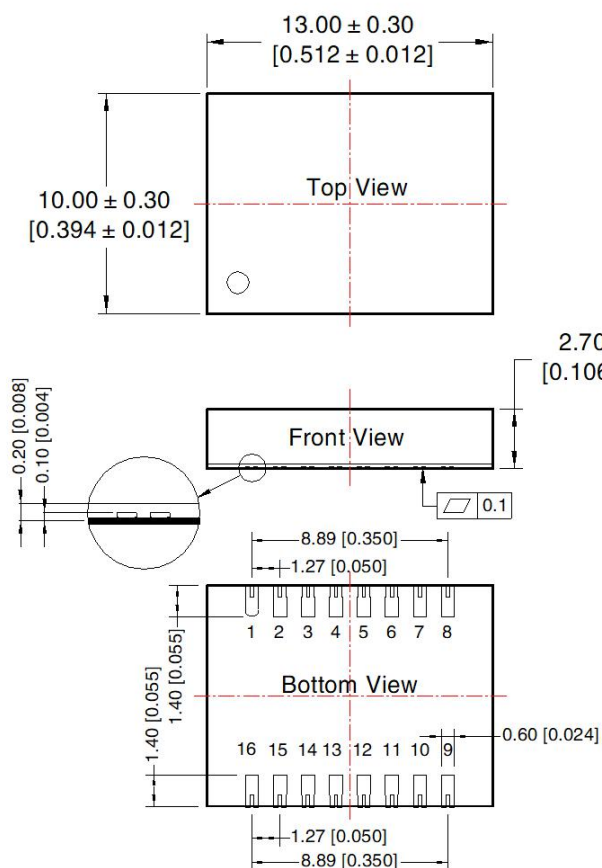

Note: Grid 2.54*2.54mm

Pin-Out			
Pin	Mark	Pin	Mark
1	GND1	9	GND2
2	VCC	10	VISOOUT
3	RXD	11	NC
4	RE	12	NC
5	DE	13	B
6	TXD	14	A
7	VCC	15	VISOIN
8	GND1	16	GND2

Note:
 Unit: mm[inch]
 General tolerances: ± 0.10 [± 0.004]

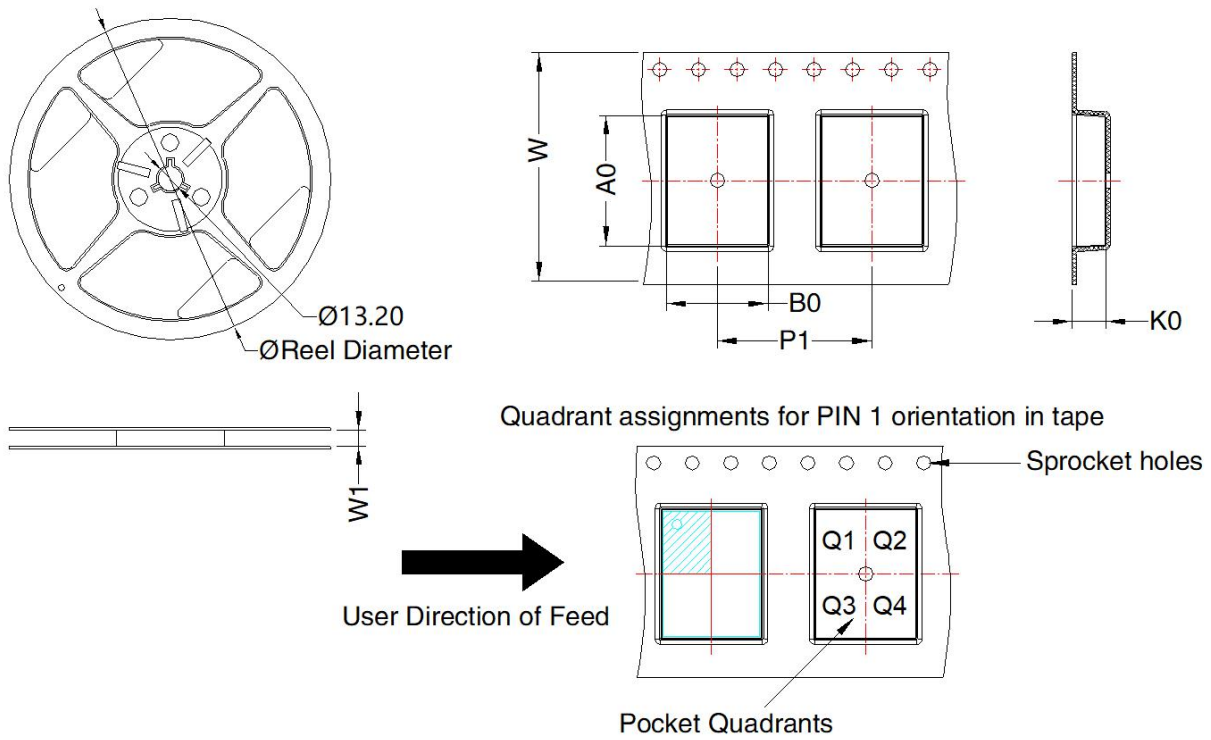

Device	Package Type	Pin	MPQ	Reel Diameter (mm)	Reel Width W1 (mm)	A0 (mm)	B0 (mm)	K0 (mm)	P1 (mm)	W (mm)	Pin1 Quadrant
TD541S485H-S	DFN 10x13	16	300	180.0	24.4	13.52	10.52	3.5	16.0	24.0	Q1

MORNSUN Guangzhou Science & Technology Co., Ltd.

Address: No. 5, Kehui St. 1, Kehui Development Center, Science Ave., Guangzhou Science City, Huangpu District, Guangzhou, P. R. China
 Tel: 86-20-38601850 Fax: 86-20-38601272 E-mail: info@mornsun.cn www.mornsun-power.com