

TD041S485H DFN package isolated RS485 Transceiver

Features

- Ultra-small, ultra-thin, chip scale DFN package
- Compliant with TIA/EIA-485A standard
- I/O power supply range supports 3.3V and 5V microprocessors
- High isolation to 3750Vrms
- Bus-Pin ESD protection up to 15kV(HBM)
- Baud rate up to 1Mbps
- > 25kV/μs CMTI
- Low communication delay
- 1/8 unit load—up to 256 nodes on a bus
- Bus fail-safe
- Bus driver short circuit protection
- Industrial operating ambient temperature range: -40°C to +105°C
- Meet AEC-Q100 Standards
- EN62368 approval
- Moisture Sensitivity Level (MSL) 3

Applications

- Industrial Automation
- Building Automation
- Smart Electricity Meter
- Remote Signal Interaction, Transmission

Functional Description

TD041S485H is a half-duplex enhanced transceiver designed for RS-485 data bus networks, which is fully compliant with TIA/EIA-485A standard and is suitable for data transmission of up to 1 Mbps. Their logic side supports 3.3V and 5V logic level conversion. Receivers have an exceptionally high input impedance, which places only 1/8 of the standard load on a shared bus and up to 256 transceivers.

TD041S485H reliability design of A, B pin is emphasized, including driver output over current protection and enhanced ESD design. The ESD protection level of A,B pin can be up to 15KV (Human Body Model).

Package

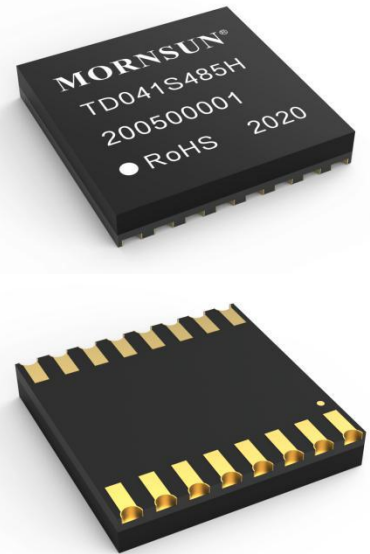

Contents

1 Home.....1	4 Characteristic Curve.....5
1.1 Feature and Package.....1	4.1 Typical Performance Curve.....5
1.2 Applications.....1	4.2 Parameter Measurement Information.....5
1.3 Functional Description.....1	5 Product Working Description.....6
2 Pin Connection and Description.....2	6 Application Circuit.....7
3 IC Related parameters.....3	7 Suggestions for Power Supply.....8
3.1 Absolute Maximum Rating.....3	8 Order Information.....8
3.2 Recommended Operating Conditions.....3	9 Package Information.....8
3.3 Electrical Characteristics.....4	10 Tape & Reel Information.....9
3.4 Transmission Characteristics.....4	
3.5 Physical Specifications.....5	

Pin Connection

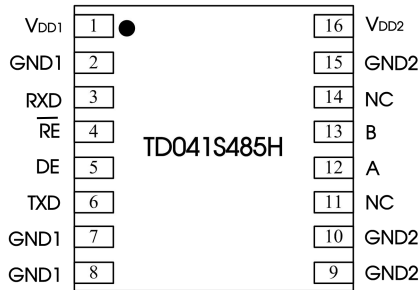

Note: All GND1 pins are internally connected;
All GND2 pins are internally connected.

Internal Block Diagram

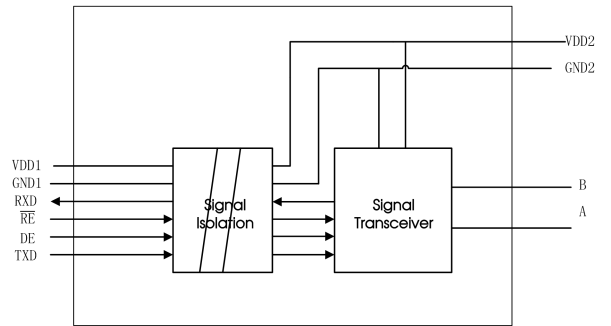

Function Table

Letter	Description
H	High-Level
L	Low-Level
X	Unrelated
Z	High Impedance
NC	No Connection

Table 1. Driver Function Table

Power		Input		Output	
VDD1	VDD2	DE	TXD	A	B
On	On	H	H	H	L
On	On	H	L	L	H
On	On	L	X	Z	Z
On	Off	X	X	Z	Z
Off	Off	L	L	Z	Z
Off	Off	X	X	Z	Z

Table 2. Receiver Function Table

Power		Input		Output
VDD1	VDD2	A-B (V)	RE	RxD
On	On	≥ -0.02	L or NC	H
On	On	≤ -0.22	L or NC	L

On	On	$-0.22 < A - B < -0.02$	L or NC	Indeterminate
On	On	OPEN	L or NC	H
On	Off	X	L or NC	H
Off	Off	X	L or NC	L

Pin Descriptions

Pin Number	Pin Name	Pin Functions
1	VDD1	Power Supply(Logic side)
2	GND1	Ground(Logic side)
3	RXD	Receiver Output Data
4	\overline{RE}	Receiver Enable Input. When \overline{RE} is low, if $(A-B) \geq -20$ mV, then RxD = high. If $(A-B) \leq -220$ mV, then RxD = low.
5	DE	Driver Enable Input. When DE is high, outputs are enabled. When DE is low, outputs are high impedance. Drive DE low and \overline{RE} high to enter shutdown mode.
6	TXD	Driver Input
7	GND1	Ground(Logic side)
8	GND1	Ground(Logic side)
9	GND2	Ground (Bus Side)
10	GND2	Ground (Bus Side)
11	NC	No Connect
12	A	RS485 Bus A Line
13	B	RS485 Bus B Line
14	NC	No Connect
15	GND2	Ground (Bus Side)
16	VDD2	Power Supply (Bus Side)

Absolute Maximum Ratings

General test conditions: Free-air, normal operating temperature range (unless otherwise specified).

PARAMETERS	UNIT
V_{DD1}	-0.5 V to +7 V
V_{DD2}	-0.5 V to +6 V
Digital Input Voltage (DE, \overline{RE} , TXD)	-0.3V to +6V
Digital Output Voltage (RxD)	-0.3V to +6V
Driver Output / Receiver input Voltage	-8 V to +13 V
Operating Temperature Range	-40°C to +105°C
Storage Temperature Range	-50°C to +125°C
Reflow Soldering Temperature	Peak temp. $\leq 260^{\circ}\text{C}$, maximum duration $\leq 60\text{s}$ at 217°C . Please also refer to IPC/JEDEC J-STD-020D.3.

Important: Exposure to Absolute Maximum Rated conditions for an extended period may severely affect the device reliability, and stress levels exceeding the "Absolute Maximum Ratings" may result in permanent damage.

Recommended Operating Conditions

Recommended Operating Conditions		Min.	Typ.	Max.	Unit
V_{DD1}	Logic Power Supply	2.375	3.3	5.5	V
V_{DD2}	Bus Power Supply	4.5	5	5.5	
V_{OC}	Voltage at any bus terminal (differential or common mode)	-7		12	
V_{IH}	High-level input voltage(TXD, DE, \overline{RE})	2		V_{DD1}	
V_{IL}	Low-level input voltage(TXD, DE, \overline{RE})	0		0.8	
V_{ID}	Differential input voltage	-7		+12	
R_L	Differential output load resistance	54	60		Ω

Recommended Operating Conditions		Min.	Typ.	Max.	Unit
Signaling rate				1000	kbps

Electrical Characteristics

General test conditions and $V_{DD1}=V_{DD2}=5V$, $T_a = 25^\circ C$ (unless otherwise specified).

PARAMETERS		CONDITIONS		Min.	Typ.	Max.	Unit
DRIVER							
V _{OD}	Differential Driver Output	R _L = ∞, Figure 9				5	V
		R _L = 27 Ω (RS-485), Figure 9		1.5		5	V
		V _{TEST} = -7 V to +12 V, V _{DD1} ≥ 4.75, Figure 10		1.5		5	V
Δ V _{OD}	Δ V _{OD} for Complementary Output States	R _L = 27 Ω, Figure 9				0.2	V
V _{OC(SS)}	Common-Mode Output Voltage	Figure 10				3	V
ΔV _{OC(SS)}	Δ V _{OC} for Complementary Output States	Figure 10				0.2	V
I _{OS}	Output Short-Circuit Current	-7V ≤ V _A or V _B ≤ 12V			±110	±250	mA
V _{IH}	Input High Voltage	TXD, DE, \overline{RE}		2			V
V _{IL}	Input Low Voltage	TXD, DE, \overline{RE}				0.8	V
R _{TXD}	Internal TXD Pull up Resistor				9.1		kΩ
R _{DE} , R _{\overline{RE}}	Internal DE, \overline{RE} Pull down Resistor				9.1		kΩ
RECEIVER							
V _{IT(+)}	Positive Differential Input Threshold Voltage	-7 V ≤ V _A or V _B ≤ +12 V				-20	mV
V _{IT(-)}	Negative Differential Input Threshold Voltage	-7 V ≤ V _A or V _B ≤ +12 V		-220			mV
V _{hys}	Hysteresis Voltage (V _{IT+} - V _{IT-})	-7 V ≤ V _A or V _B ≤ +12 V			20		mV
R _{ID}	Differential Input Resistance(A,B)	-7 V ≤ V _A or V _B +12 V		96			kΩ
I _I	Input Current (A, B)	DE=0, \overline{RE} =0	V _I =12V		190	250	uA
			V _I = -7V	-200	-110	uA	
V _{OH}	RXD Output High Voltage	I _{OUT} = 20 μA, V _A - V _B = 0.2 V		V _{DD1} - 0.1			V
		I _{OUT} = 4 mA, V _A - V _B = 0.2 V		V _{DD1} - 0.4	V _{DD1} - 0.2		V
V _{OL}	RXD Output Low Voltage	I _{OUT} = -20 μA, V _A - V _B = 0.2 V				0.1	V
		I _{OUT} = -4 mA, V _A - V _B = 0.2 V				0.4	V
Supply and Protection							
I _{DD1}	Supply Current(Logic side)	4.5 V ≤ V _{DD1} ≤ 5.5 V, No load, \overline{RE} = 0 V				4.5	mA
		3.0 V ≤ V _{DD1} ≤ 3.6 V, No load, \overline{RE} = 0 V				4.5	mA
I _{DD2}	Supply Current(Bus side)	No load, DE = 5 V				6	mA
		No load, DE = 0 V				6	mA
ESD	HBM	A, B and GND				±15	kV
		Other pins				±2	kV
	IEC/EN 61000-4-2 (Contact) Perf. Criteria B	A, B and GND				±4	kV
EFT	IEC61000-4-4 : Perf. Criteria B	A, B and GND				±2	kV
Surge	IEC61000-4-5 : Perf. Criteria B	A, B and GND(Common Mode)				±2	kV
V _{I-O}	Isolation Test	Leakage current <1mA.				3750	Vrms
R _{I-O}	Insulation Resistance	At 500VDC		1000			MΩ
C _{I-O}	Isolation capacitor				3		pF
CMTI	Common Mode Transient Immunity	TXD = V _{DD1} or 0 V, VCM = 1 kV, transient magnitude = 800 V		25			kV/μs

Transmission Characteristics

General test conditions and $V_{DD1}=V_{DD2} = 5V$, $T_a = 25^\circ C$ (unless otherwise specified).

PARAMETERS		CONDITIONS	Min.	Typ.	Max.	Unit
Maximum Data Rate					1	Mbps
DRIVER						
t_{PLH}, t_{PHL}	Propagation Delay	$R_L = 54 \Omega, C_{L1} = C_{L2} = 100 \text{ pF}$, Figure11		40	110	ns
t_{SKEW}	Skew ($ T_{PHL} - T_{PLH} $)				40	ns
t_r, t_f	Rise/Fall Time			50	120	ns
RECEIVER						
t_{PLH}, t_{PHL}	Propagation Delay	$C_L = 15 \text{ pF}$, Figure12		60	110	ns
t_{SKEW}	Differential Skew ($ T_{PLH} - T_{PHL} $)				250	ns

Physical Specifications

PARAMETERS	Value	Unit
Weight	0.4(Typ.)	g

Typical Performance Curves

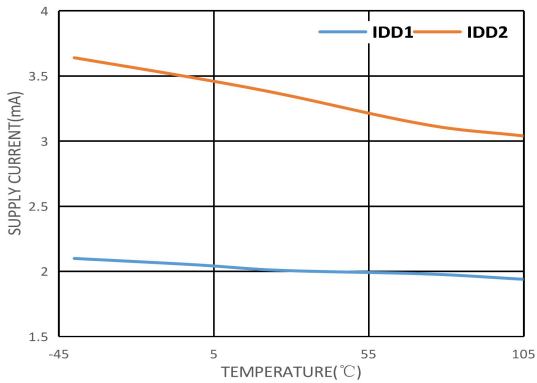

Figure3. Unloaded Supply Current vs. Temperature

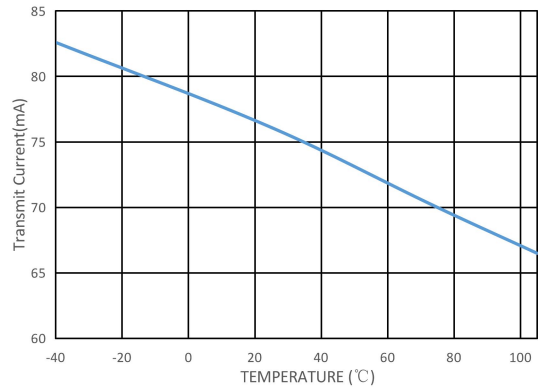

Figure4. Transmit Current vs. Temperature, $V_{DD1}=5V, V_{DD2}=5V$

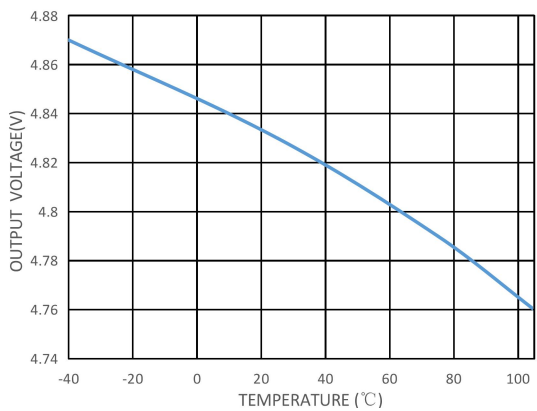

Figure5. Receiver Output High Voltage vs. Temperature

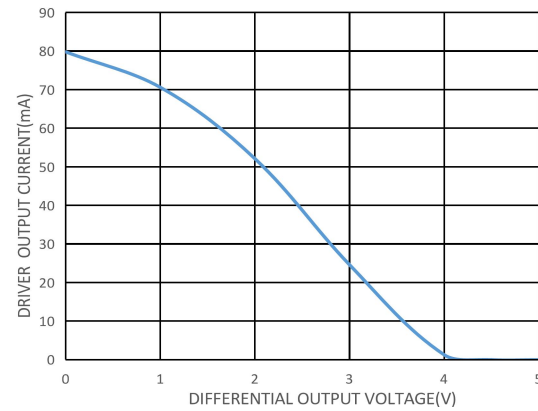

Figure6. Driver Output Current vs. Differential Output Voltage

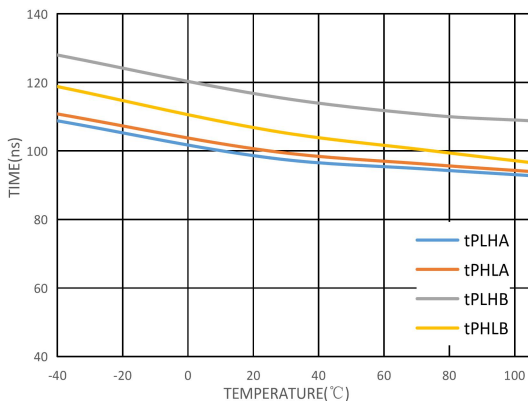

Figure 7. Driver Propagation Delay vs. Temperature

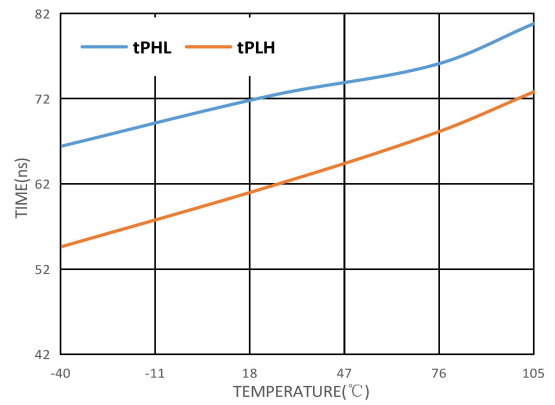

Figure 8. Receiver Propagation Delay vs. Temperature

Test Circuits

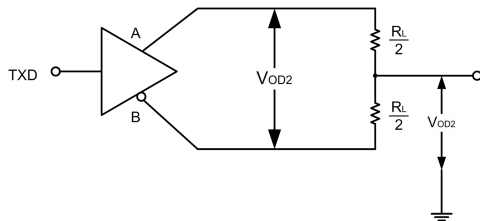

Figure 9. Driver Test Circuit

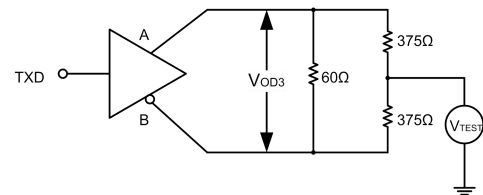

Figure 10. Driver Test Circuit, VOD With Common-Mode Loading

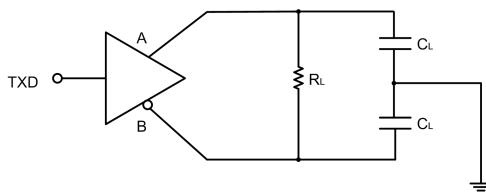

Figure 11. Drive propagation delay test circuit and wave forms

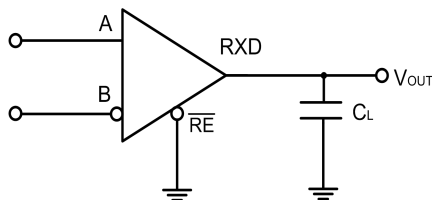
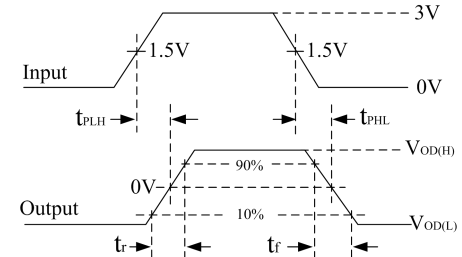
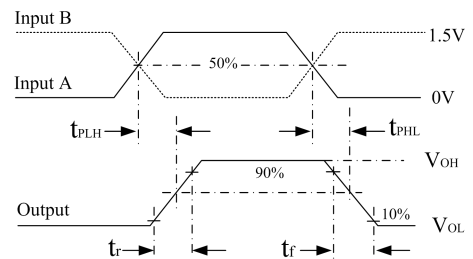

Figure 12. Receiver propagation delay test circuit and wave forms



Detailed Description

TD041S485H is an advanced RS-485 transceivers. They each contain one driver and one receiver. These devices feature a fail-safe circuitry that guarantees a high receiver output voltage when the receiver inputs are either open, shorted or when they are connected to a terminated transmission line with all drivers disabled. TD041S485H operates with a two power supply. Their logic side supports 3.3V and 5V logic level conversion. The whole machine can monitor the overall working state of the module and limit the output high current to prevent the bus from overload or short circuit causing unrecoverable damage to the transceiver.

Receiver input filter: TD041S485H receiver have an integrated input filter which enhances noise immunity of the high-speed differential signals. The receiver propagation delay increases due to this filtering.

Bus fail-safe: Ordinary RS485 bus receivers will be in an indeterminate state when $-220\text{mV} < A - B < -20\text{mV}$. This situation can occur whenever the data bus is not being actively driven. The advanced Fail-safe feature of the TD041S485H guarantees a high receiver output voltage if the receiver's differential inputs are either shorted, open circuit, or if they are connected to a termination resistor.

The TD041S485H receiver thresholds are very precise, and the offset between threshold voltage and ground has a margin of at least 10mV. This guarantees that the receiver output is a high voltage even the input differential is zero volts, thus maintaining compliance with the EIA/TIA-485 standard.

Load abilities on the bus (256 nodes): The standard receiver input impedance of RS-485 is 12kΩ (1 unit load). A standard RS485 driver can drive at least 32 unit loads. The TD(H)041S485H transceiver is designed to 1/8th of the standard unit load and the input impedance is higher than 96kΩ, hence allowing up to 256 unit loads. The TD(H)041S485H can work combined with other standard RS485 that use the smaller amount of unit loads.

Low power shutdown mode: A low-power shutdown mode is triggered by simultaneously bringing high and DE low. During shutdown mode the device supply current is 6mA typical. DE and can be directly connected and controlled by the same I/O. The devices are guaranteed not to enter shutdown mode if is high and DE is low for less than 50ns. If this state is maintain for at least 600ns, the device will shutdown reliably.

Driver output protection: The device prevents excessive output current caused by fault conditions or driver short circuit. A driver current limit on the output stage provides and ensures immediate protection against short circuits over the entire common mode voltage range.

Application circuit

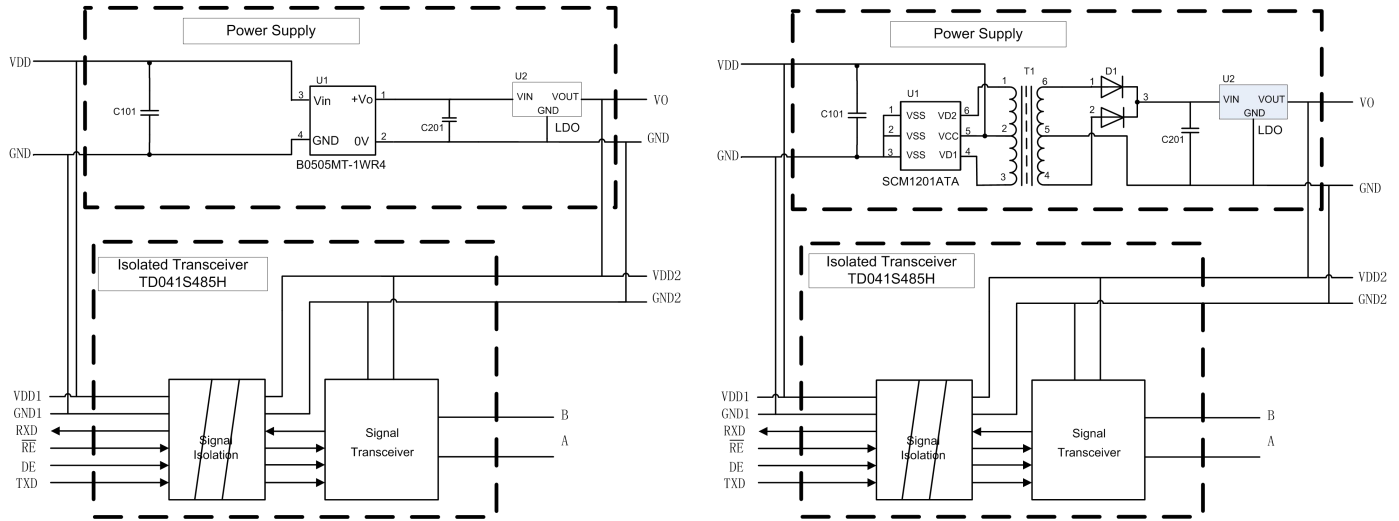

Figure 13. Receiver propagation delay test circuit and wave forms

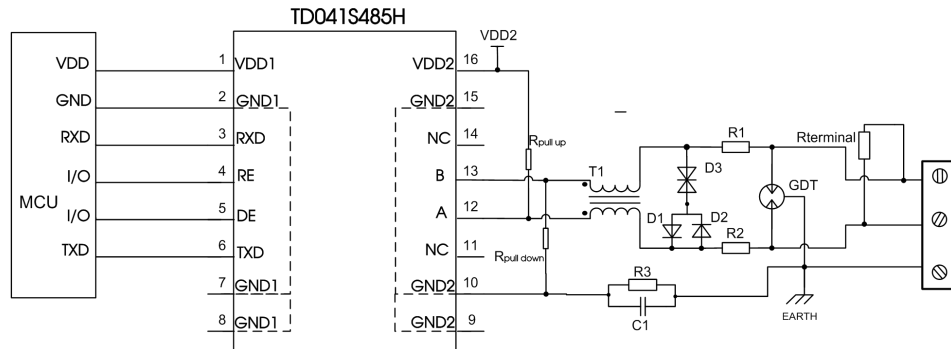

Figure 14. Port protection circuit for harsh environments

Recommended components and values:

Component	Recommended part, value	Component	Recommended part, value
R3	1MΩ	R1, R2	2.7Ω/2W
C1	1nF, 2kV	D1, D2	1N4007
T1	ACM2520-301-2P	D3	SMBJ8.5CA
GDT	B3D090L	R _{terminal}	120 Ω

As the modules internal A / B lines come with its own ESD protection, which generally satisfy most application environments without the need for additional ESD protection devices. For harsh and noisy application environments such as motors, high voltage/current switches, lightning and similar however, we recommended that the user protects the module' s A / B lines with additional measures and external components such as TVS tube, common mode inductors, Gas discharge tube, shielded twisted pair of wires with the same single network Earth point. Figure 14 shows our recommended circuit diagram for such type of applications with components and values given in the table above. This recommendation is for reference only and may have to be adapted accordingly with appropriate component values in order to match the actual situation and application.

Note: Select the R_{terminal} according to the actual application.

Using Suggests

- ① Hot-swap is not supported.
- ② If the external input of TXD is insufficient, the pull-up resistor should be added according to the situation.
- ③ Refer to *IPC 7093* for the welding process design of this product. For detailed operation guidance, please refer to *Hot Air Gun Welding Operation Instruction for DFN Package Product* or *Welding Operation Instruction for DFN Package Product*.

Ordering Information

Part number	Package	Number of pins	Product Marking	Tape & Reel
TD041S485H	DFN	16	TD041S485H	500/REEL

Package Information(DFN-16)

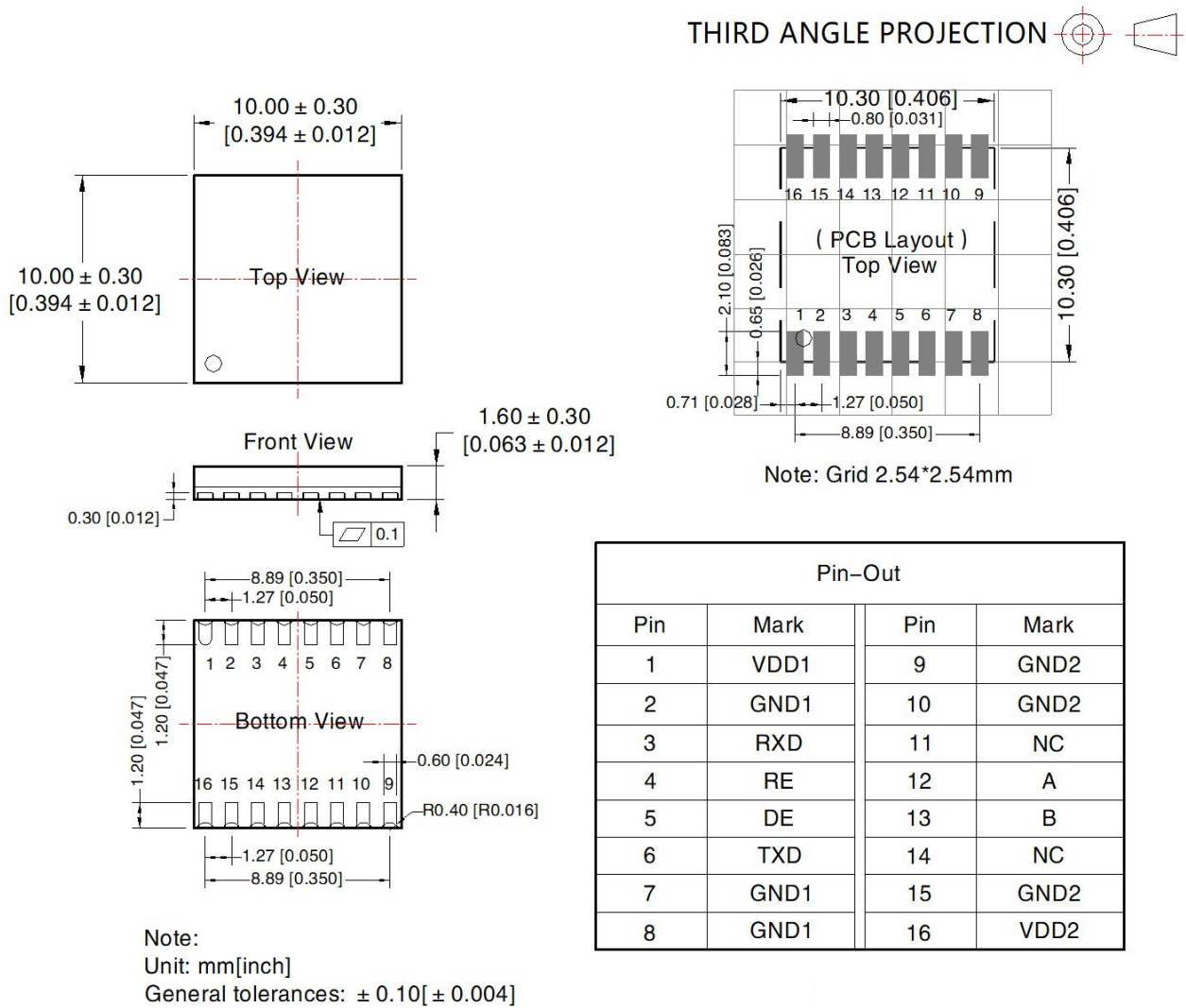

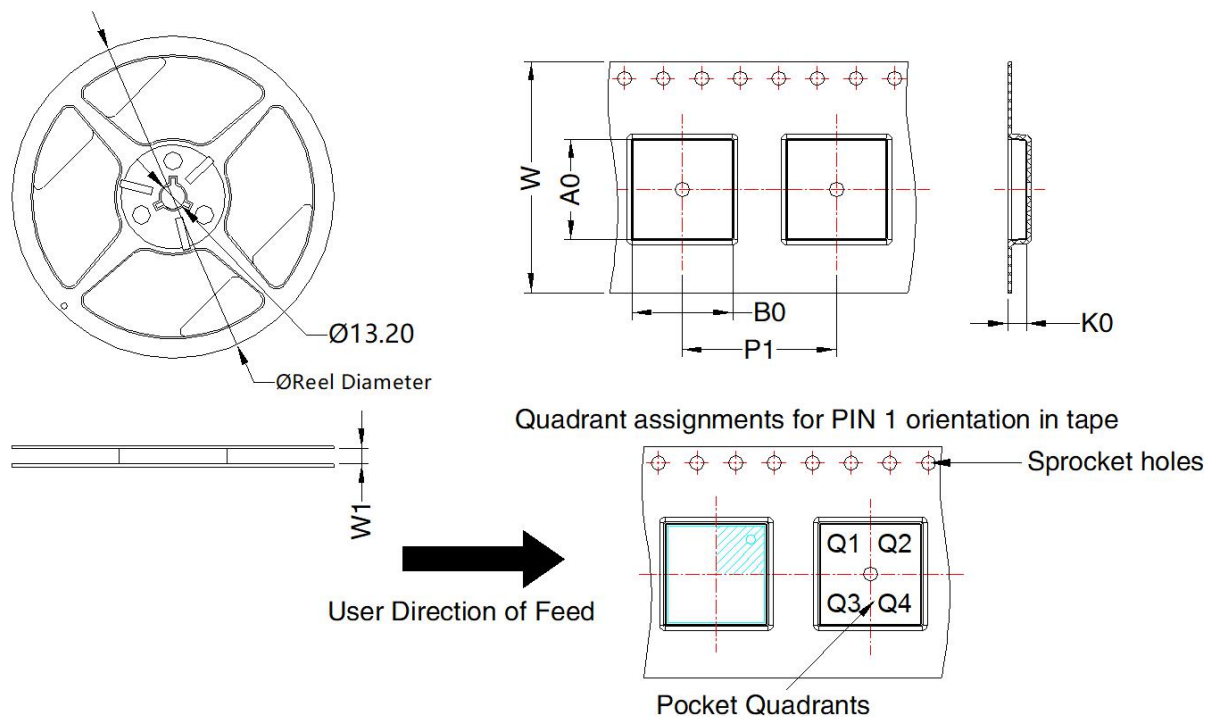

Device	Package Type	Pin	MPQ	Reel Diameter (mm)	Reel Width W1 (mm)	A0 (mm)	B0 (mm)	K0 (mm)	P1 (mm)	W (mm)	Pin1 Quadrant
TD(H)041S485H	DFN 10x10	16	500	180.0	24.4	10.44	10.44	2.0	16.0	24.0	Q2

MORNSUN Guangzhou Science & Technology Co., Ltd.

Address: No. 5, Kehui St. 1, Kehui Development Center, Science Ave., Guangzhou Science City, Huangpu District, Guangzhou, P. R. China
 Tel: 86-20-38601850 Fax: 86-20-38601272 E-mail: info@mornsun.cn www.mornsun-power.com