

DC/DC Converter for IGBT Driver QAU242D2G

MORNSUN®

7.2W isolated DC-DC Converter for IGBT driver
Ultra-wide input voltage and regulated dual output



Patent Protection RoHS

FEATURES

- Ultra-wide input voltage range (4:1)
- High efficiency up to 85%
- Input-Output isolation test voltage: 4.2kVAC
- Output-Output isolation test voltage: 3.0kVAC
- Operating ambient temperature range: -40°C to +105°C
- Input under-voltage protection, output short-circuit protection, over-voltage protection
- No-load operation allowed
- Reinforced Insulation design
- IGBT dedicated regulated DC-DC converter

QAU242D2G is DC-DC converter for IGBT drivers. It offers output power up to 7.2w, features with output over-voltage protection, short-circuit protection and self-recovery capability. General application includes:

1. Universal converter
2. AC servo drive system
3. Electric welding machine
4. Un-interruptible power supply (UPS)

Selection Guide

Part No.	Input		Output		Full Load Efficiency (%) Typ.	Max. Capacitive Load ^① (μF)
	Voltage(VDC) (Range)	Current(mA, Typ.) Full Load/No Load	Voltage (VDC) Vo1/Vo2	Current (mA) Max./Min.		
QAU242D2G	24 (9-36)	353/10	24/24	150/0	85	470

Notes: ①The specified maximum capacitive load value for positive and negative output is identical.

Input Specifications

Item	Operating Conditions	Min.	Typ.	Max.	Unit
Input Current (full load / no-load)	Nominal input voltage	--	353/10	--	mA
Reflected Ripple Current		--	55	--	
Surge Voltage (1sec. max.)		-0.7	--	50	VDC
Start-up Voltage		--	--	9	
Input Under-voltage Protection		5.5	6.5	--	
Input Filter		Capacitance filter			
Hot Plug		Unavailable			

Output Specifications

Item	Operating Conditions	Min.	Typ.	Max.	Unit
Output Power		0	--	7.2	W
Voltage Accuracy	5%-100% load	Vo1	±1	±2.5	%
		Vo2	±1	±2.5	
Linear Regulation	Input voltage variation from low to high at full load	Vo1	±0.2	±0.5	
		Vo2	±0.8	±1.2	
Load Regulation	5%-100% load	Vo1	±0.5	±1	
		Vo2	±1	±1.5	
Transient Recovery Time	25% load step change, nominal input voltage	--	300	500	μs
Transient Response Deviation		--	±3	±5	%
Temperature Coefficient	Full load	--	--	±0.03	%/°C
Ripple & Noise*	20MHz bandwidth	--	75	150	mV p-p
Over-voltage Protection	Input voltage range	110	--	160	%Vo

MORNSUN®

MORNSUN GUANGZHOU SCIENCE & TECHNOLOGY CO.,LTD.

2019.10.18-A/2

Page 1 of 4

MORNSUN Guangzhou Science & Technology Co., Ltd. reserves the copyright and right of final interpretation

Short-circuit Protection	Continuous, self-recovery
Note: *The "parallel cable" method is used for Ripple and Noise test, please refer to DC-DC Converter Application Notes for specific information.	

General Specifications

Item	Operating Conditions	Min.	Typ.	Max.	Unit
Isolation	Input-output Electric Strength Test for 1 minute with a leakage current of 1mA max	4200	--	--	VAC
	output-output Electric Strength Test for 1 minute with a leakage current of 1mA max	3000	--	--	
Insulation Resistance	Input-output resistance at 500VDC	1000	--	--	MΩ
Isolation Capacitance	Input-output capacitance at 100kHz/0.1V	--	15	--	pF
Operating Temperature	Derating when operating temperature up to ≥75°C (see Fig. 1)	-40	--	105	°C
Storage Temperature		-55	--	125	
Pin Soldering Resistance Temperature	Soldering spot is 1.5mm away from case for 10 seconds	--	--	300	
Storage Humidity	Non-condensing	5	--	95	%RH
Vibration		10-55Hz, 2G, 30 Min. along X, Y and Z			
Switching Frequency	PWM mode	--	300	--	kHz
MTBF	MIL-HDBK-217F@25°C	1000	--	--	K hours

Mechanical Specifications

Case Material	Black plastic; flame-retardant and heat-resistant (UL94-V0)
Dimensions	31.70 x 20.30 x 12.65 mm
Weight	13.0g(Typ.)
Cooling Method	Free air convection

Electromagnetic Compatibility (EMC)

Emissions	CE	CISPR32/EN55032	CLASS B (see Fig.4-② for recommended circuit)	
	RE	CISPR32/EN55032	CLASS B (see Fig.4-② for recommended circuit)	
Immunity	ESD	IEC/EN61000-4-2	Contact ±4kV	perf. Criteria B
	EFT	IEC/EN61000-4-4	±2kV (see Fig.4-① for recommended circuit)	perf. Criteria B
	Surge	IEC/EN61000-4-5	±2kV (see Fig.4-① for recommended circuit)	perf. Criteria B
	Voltage dips, short interruptions and voltage variations immunity	IEC/EN61000-4-29	0, 70%	perf. Criteria B

Typical Characteristic Curves

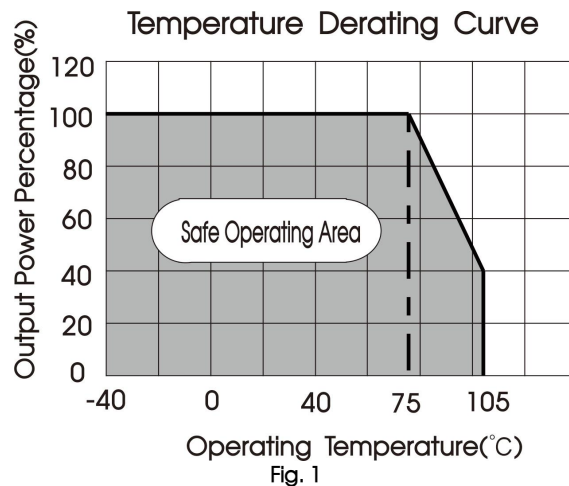

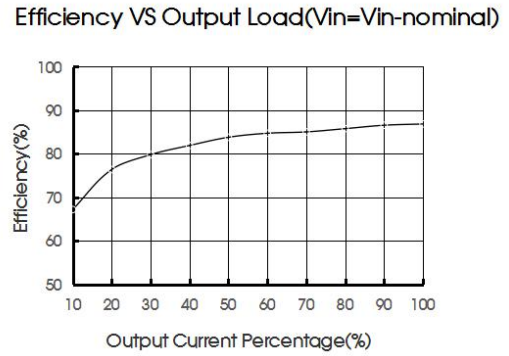
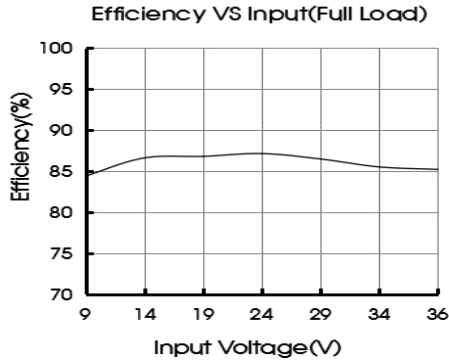

Design Reference

1.Recommended circuit

All the DC-DC converters of this series are tested before delivery using the recommended circuit shown in Fig. 2. The load of positive and negative output is identical.

Input and/or output ripple can be further reduced by appropriately increasing the input & output capacitor values C_{in} and C_{out} and/or by selecting capacitors with a low ESR (equivalent series resistance). Also make sure that the capacitance is not exceeding the max. capacitive load value of the product.

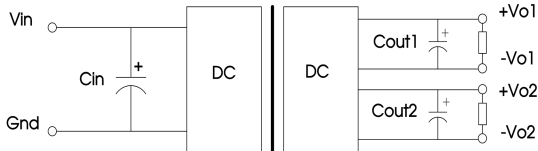

Fig. 2

Vin	24V
Cin	100μF
Cout1	100μF
Cout2	100μF

2. Typical application

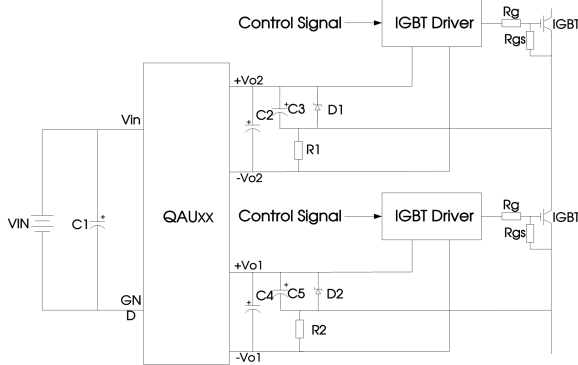

Fig. 3

C1	100uF/63V
C2, C3, C4, C5	100uF/35V
R1, R2	15KΩ
D1, D2	15V

Application Notes

1. The wire between the converter and IGBT driver must as short as possible.
2. External filter capacitors should be connected as close as possible to the IGBT driver.
3. To ensure the high peak gate current, the filter capacitors should be electrolytic capacitor and ceramic capacitor collocation.
4. The output average power of the IGBT driver should be less than the output power of DC-DC module.
5. When driving the bridge circuit, the Main output Vo1 drives the lower tube, and the Supplement output Vo2 drives the upper tube. If it is reversed, the output voltage will be unstable.

3.EMC compliance circuit

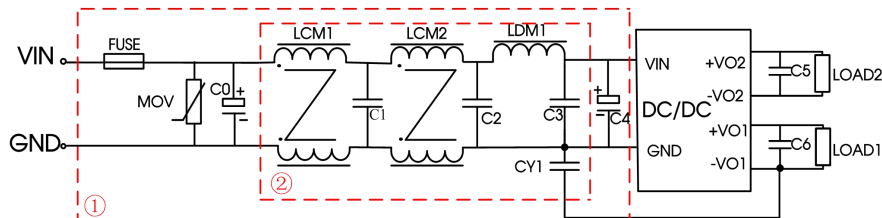

Fig. 4

Model	QAU242D2G
FUSE	Choose according to actual input current
MOV	20D560K
C0, C4	330uF/63V

C1	225K/50V
C2、C3	475K/50V
C5、C6	100uF/50V
CY1	102M/8kV
LCM1	4.8mH/2A
LCM2	2.2mH/2A
LDM1	15uH/2A

4. Electrolytic capacitors are recommended for external capacitors at the input or output of the product. Tantalum capacitors are not, otherwise there is a risk of failure.

5. The products do not support parallel connection of their output or hot-plug use

6. For additional information please refer to the application notes on www.mornsun-power.com

Dimensions and Recommended Layout

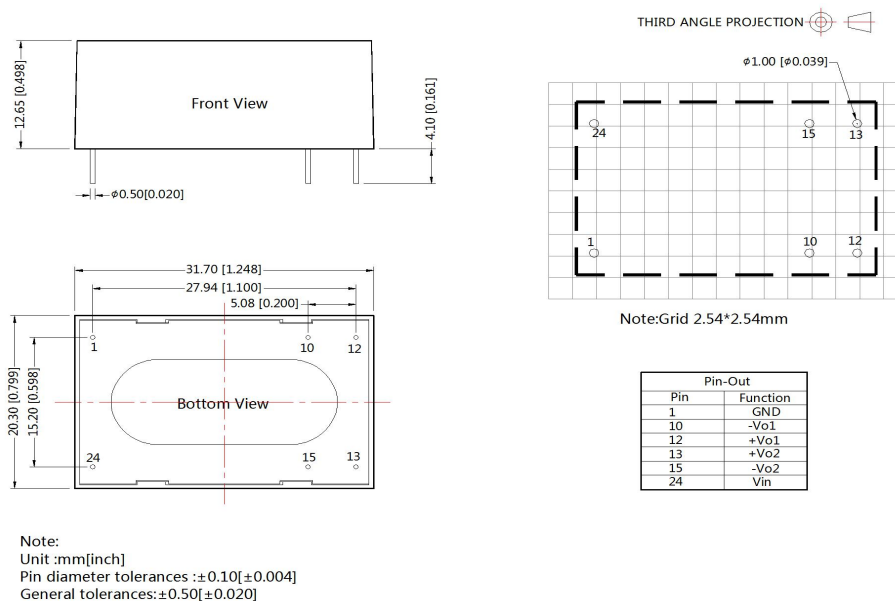

Notes:

- For additional information on Product Packaging please refer to www.mornsun-power.com. Packaging bag number: 58000150;
- The lead connecting the power supply module and IGBT driver should be as short as possible during use;
- The output filtering capacitor should be as close as possible to the power supply module and IGBT driver;
- The peak of the IGBT driver dedicated power supply gate drive current is high, so low internal resistance electrolytic capacitor is recommended to be used for the power supply module output filter capacitor;
- The average output power of the driver must be lower than that of the power supply module;
- Consider fixing with glue near the module if being used in vibration occasion;
- The maximum capacitive load offered were tested at nominal input voltage and full load;
- Unless otherwise specified, parameters in this datasheet were measured under the conditions of $T_a=25^{\circ}\text{C}$, humidity<75%RH with nominal input voltage and rated output load;
- All index testing methods in this datasheet are based on company corporate standards;
- The performance indexes of the product models listed in this manual are as above, please directly contact our technicians for specific information;
- We can provide product customization service, please contact our technicians directly for specific information;
- Products are related to laws and regulations: see "Features" and "EMC".
- Our products shall be classified according to ISO14001 and related environmental laws and regulations, and shall be handled by qualified units.

Mornsun Guangzhou Science & Technology Co., Ltd.

Address: No. 5, Kehui St. 1, Kehui Development Center, Science Ave., Guangzhou Science City, Huangpu District, Guangzhou, P. R. China

Tel: 86-20-38601850

Fax: 86-20-38601272

E-mail: info@mornsun.cn

www.mornsun-power.com

MORNSUN®

MORNSUN GUANGZHOU SCIENCE & TECHNOLOGY CO.,LTD.

2019.10.18-A/2

Page 4 of 4