



FEATURES

- Universal 85-300VAC Input voltage
- Active PFC
- Operating ambient temperature range: -40°C to +75°C (No condensation)
- High efficiency, low ripple & noise, high reliability
- Full digital control
- Support CAN bus communication function
- Perfect protection function
- 3 years warranty
- Operating altitude up to 5000m
- Support CAN bus regulating output voltage, output current and average flow function
- Support hot insertion function
- Support LED instructions alarm
- Double-sided conformal coating process with triple protection
- Design refer to IEC60950-1, IEC62368-1

The LMR4000-4875 rectifier module is the AC-DC module power supply provided by Mornsun for customers. This power supply is a high-efficiency, high-power density digital module power supply. The wide input voltage range supports 53.5VDC output voltage. It supports the expansion frame mode CAN2.0B bus communication function, the product has the advantages of perfect protection function, low ripple noise, and can be used in combination. It can be used to monitor the working status of the power supply, real-time load, and control adjustment function through the upper machine. The product has safe and reliable, EMC performance supports 5KA-level lightning protection. The security specifications meet the IEC60950-1/IEC62368-1 certification standards. Aces and other fields.

Selection Guide

Certification	Part No.	Type of cooling	Output Power	Nominal Output Voltage and Current(Vo/Io)	Output Voltage Adjustable Range (V)	Efficiency at 230VAC (%) Typ.	Capacitive Load (uF) Max.
--	LMR4000-4875	Forced cooling	4001W	53.5VDC/74.8A	42-58VDC	93%@23A load 96%@37.4A load 95%@74.8A load	100000

Note: 1.*When testing the full load conversion efficiency, the fan power is not included in the output power, and the typical fan power is 10W (TYP);
2.Output voltage can adjust value by CAN communication.

Input Specifications

Item	Operating Conditions	Min.	Typ.	Max.	Unit
Input Voltage Range	Rated input (Certified voltage)	100	--	240	VAC
	AC input	85	--	300	
Input Voltage Frequency	Rated input (Certified voltage)	50	--	60	Hz
	AC input	45	--	66	
Input Current	230VAC	--	--	21	A
Inrush Current	230VAC Cold start	--	--	20	
Power Factor	230VAC	--	0.99	--	--
THD	230VAC, 50%-100% load	--	--	5	%
Start-up Delay Time*	230VAC, rated load, Room temperature	--	--	10	s
	230VAC, rated load, Environmental temperature ≤ -10°C	--	--	80	
Hot Plug	Support hot insertion function				

Note: 1.* Start delay time: When the ambient temperature is less than-10°C and the chiller is started, the rectifier module power enters a constant output voltage and constant output current start mode. The maximum start time when the output is under rated load is 80 seconds.

Output Specifications

Item	Operating Conditions		Min.	Typ.	Max.	Unit
Output Voltage Accuracy	Full load range		--	--	0.6	%
Line Regulation	Rated load		--	--	1	
Load Regulation	0% - 100% load		--	--	1	
Minimum Load			0	--	--	
Stand-by Power Consumption	nominal Input Voltage(230VAC), Room temperature		--	--	8	W
Ripple & Noise*	20MHz bandwidth (peak-peak value)	nominal Input Voltage(230VAC)	--	--	200	mV
Temperature Coefficient			--	±0.03	--	%/°C
Hold-up Time*	230VAC ,rated load		--	10	--	ms
Short Circuit Protection*	230VAC		constant current works, , self-recover			
Over-current Protection*	230VAC	Room temperature high temperature Low Temperature	> 1.05 I _o , constant current works, , self-recover			
Over-voltage Protection*	230V		< 60.5VDC,self-recover			
Over-temperature Protection	230VAC , 100%load	Over-temperature protection start	--	--	70	°C
		Over-temperature protection release	50	--	--	



Note:1. *The "Tip and barrel method" is used for ripple and noise test, output parallel 47uF electrolytic capacitor and 0.1uF ceramic capacitor, please refer to Enclosed Switching Power Supply Application Notes for specific information,when the input voltage is high(above 264Vac),the ripple and noise will be different;
2. *Output overvoltage protection, the upper machine can set the specific overvoltage protection value;
3. *Hold-up Time,Keep the power loss time, and determine that the output voltage is dropped to 80%of the output voltage to 80%of the rated output voltage;
4. *Short -circuit Protection:After removing the output short -circuit protection, and the output load current is less than 33A, the output voltage can be restored by itself;
5. *Over-current Protection:The output constant current point can be adjusted by CAN communication, after removing the output over-current Protection, and the output load current is less than 33A, the output voltage can be restored by itself.

General Specifications

Item	Operating Conditions		Min.	Typ.	Max.	Unit	
Isolation Test*	Input - ⊕	Electric strength test for 1min., leakage current <30mA	1500	--	--	VAC	
	Input - output		3000	--	--		
	Output - ⊕	Electric strength test for 1min., leakage current <45mA	500	--	--		
Insulation Resistance*	Input - ⊕	Ambient temperature: 25 ± 5°C Relative humidity: < 95%RH, no condensation Test voltage: 500VDC	100	--	--	MΩ	
	Input - output		100	--	--		
	Output - ⊕		100	--	--		
Operating Temperature			-40	--	75	°C	
Storage Temperature			-40	--	85		
Storage Humidity	no condensation		10	--	95	%RH	
Operating Humidity			20	--	90		
switching frequency	PFC		--	55	--	KHz	
	DC-DC		--	85	--		
Power Derating	Operating temperature derating	53.5V	50°C-75°C	2	--	--	% / °C
			75°C-80°C	10	--	--	
	Input voltage derating		85VAC-176VAC	0.659	--	--	% / VAC
Leakage Current	230VAC, 60Hz	Touch current	<2.5mA				
Safety Standards			Safety according to IEC60950-1, IEC62368-1				
Safety Class			CLASS I				
MTBF	MIL-HDBK-217F@25°C		≥500000 h				
Warranty	Ambient temperature: <25°C		3years				

Note: 1. *When testing insulation and resistance, you should first remove the GDT screw; ⚡
2. *When testing the insulation resistance, remove the GDT screw first. ⚡

Functional Specifications*

Item	Operating Conditions	Min.	Typ.	Max.	Unit	
Remote Control Switch	All input voltage range, all load range	Through the CAN bus communication control				
The output voltage can set the value	Repeat settings, the interval time is less than 1 minute	41.5	--	58.5	V	
The default value settings of the output voltage	Just set once	42	--	58		
Output overvoltage protection can set value	All input voltage range, all load range	56	--	61.5		
Output current limit flow multiplier setting	Just set once	0.55	--	1.22		
Input current limit flow setting	All input voltage range, all load range	0	--	100	/	
Input voltage display accuracy	nominal Input Voltage(230VAC), rated load	--	2	--	%	
Input current display accuracy	nominal Input Voltage(230VAC), rated load	--	5	--		
Output voltage display accuracy	rated load	--	1.5	--		
Output current display accuracy	rated load	--	6	--		
Fan speed display accuracy	All input voltage range, all load range	--	10	--		
Vascope environmental temperature accuracy	Room temperature	--	5	--		
PFC topological work temperature display accuracy	Room temperature	--	5	--		
DC/DC topological work temperature display accuracy	Room temperature	--	5	--		
WALK-in start-delay settings	Walk-in start-delay setting range S (8s-200s)					
Power module order start time interval settings	Setting time interval setting of the power module sequence S (0s-20s)					
Power module output overvoltage protection mode setting	Power off restart and restore the output voltage by yourself Restart the output voltage by yourself					
Power module performs address redistribution control	Power and parallel application, use the competitive address distribution mechanism					
Work status and warning LED light	Running status, warning, failure					
Cumulative operation time of the power module		10	--	--	years	
Power module parameter information read	Including the rated output information of the power module and the SN code and other information					
Multi -module parallel work average flow accuracy	The output load power is greater than 50%of the rated load.	--	5	--	%	
green light	Running		Constant on	Rectifier module has AC input normal state, no need to deal with		
			Constant extinction	1. Without AC input, check whether the AC input is normal, such as If AC input is normal, replace the rectifier module; 2. The inside of the rectifier module is damaged. Replace the rectifier module.		
			0.5Hz flicker	Manual query status Normal status, no need to process.		
			4 Hz flicker	Rectifier module is in application program loading state and automatically recovers after loading without processing.		
Yellow light	warning		Constant extinction	Rectifier module is in normal state without protection alarm, and no processing is required.		
			Constant on	1. Power limit pre-alarm of rectifier module caused by too high ambient temperature; protection shutdown alarm caused by too high ambient temperature; check whether the vent of rectifier module is blocked and whether the ambient temperature is normal;		

				<p>2. Check the grid voltage for AC input overvoltage and undervoltage protection; 3. The rectifier module is in a normal state of dormancy and shutdown and does not need to be processed.</p>
			0.5Hz flicker	Communication between the rectifier module and the outside is interrupted. Replace the rectifier module or the monitoring module.
red light	failure		Constant extinction	Rectifier module is in normal state without fault, and no treatment is required.
			Constant on	<p>1.The module is not inserted properly. Remove the rectifier module and wait for more than 1 minute before confirming. 2. If there is no output caused by internal fault of rectifier module, replace the rectifier module.</p>
Note: 1.*For details, please inquire about our technical service staff.				

Environmental Characteristics

Item	Operating Conditions	Standard
High and Low Temperature Working	+75℃, -40℃	GB2423.1、GB2423.2、IEC60068-2-1
Sinusoidal Vibration	10-500Hz, 2G 10min/T, three directions of X, Y, Z axis	GB2423.10、IEC60068-2-6
Low Temperature Storage	-40℃	GB2423.1、IEC60068-2-1
High Temperature Storage	+85℃	GB2423.2、IEC60068-2-2
High Temperature Aging	+50℃	GB2423.2、IEC60068-2-2
Normal Temperature Aging	+25℃	GB2423.1、IEC60068-2-1
Temperature Shock	-40℃ to +75℃	GB2423.22、IEC60068-2-14
Temperature Cycle	-25℃ to +50℃	GB2423.22、IEC60068-2-14
Packaging Drop	1m, one corner, three edges and six sides	GB2423.8、IEC68-2-32

General Specifications

Case Material	Metal (SGCC) and (AL6063)
Dimensions	40.8mm*105mm*269mm
Weight	1950g (Typ.)
Cooling Method	Forced cooling/ 32CFM (Typ.)

Electromagnetic Compatibility (EMC)

Emissions	CE (Input port)	CISPR32 EN55032 150K - 30MHz	CLASS A	
	RE	CISPR32 EN55032 30MHz - 1GHz	CLASS A	
	Harmonic current	IEC/EN61000-3-2	CLASS A	
Immunity	ESD	IEC/EN61000-4-2 Contact1±6KV/Air ±8KV	perf. Criteria A	
	RS	IEC/EN61000-4-3 10V/m		
	EFT (Input port)	IEC/EN61000-4-4 ±4KV		
	Surge (Input port)*	IEC/EN61000-4-5 line to line ±2KV/line to ground ±4KV		
	MS	IEC/EN61000-4-8 30A/m		
	CS	IEC/EN61000-4-6 0.15 - 80MHz 10Vr.m.s		
	Voltage dips	IEC/EN61000-4-11	0% of 230Vac, 0Vac, 20ms	perf. Criteria B
			40% of 230Vac, 11.5Vac, 10ms	perf. Criteria B
70% of 230Vac, 161Vac, 500ms			perf. Criteria B	
Voltage interruption	IEC/EN61000-4-11	0% of 230Vac, 0Vac, 5000ms	perf. Criteria B	

Note: 1. *perf. Criteria:

A: The equipment shall continue to operate as intended without operator intervention;

B: After the test, the equipment shall continue to operate as intended without operator intervention;

C: Loss of function is allowed, provided the function is self-recoverable, or can be restored by the operation of the controls by the user in accordance with the manufacturer's instructions.

D: The functional reduction or loss of function due to damage is damaged.

2'Before testing lightning waves, you should first confirm that the GDT screw has been installed. ⚡

Product Characteristic Curve

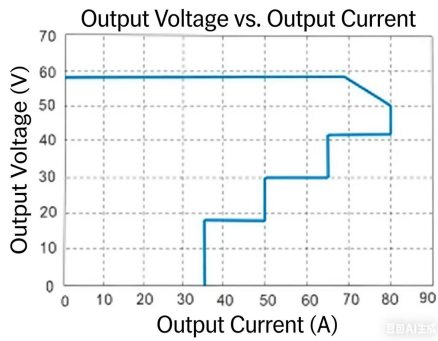

figure1

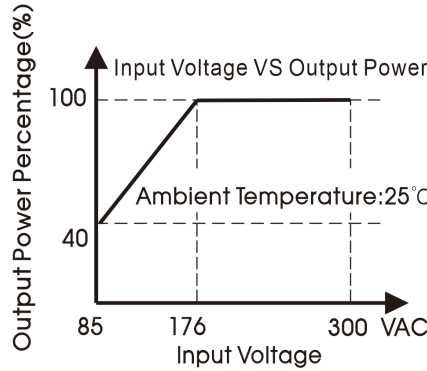

figure2

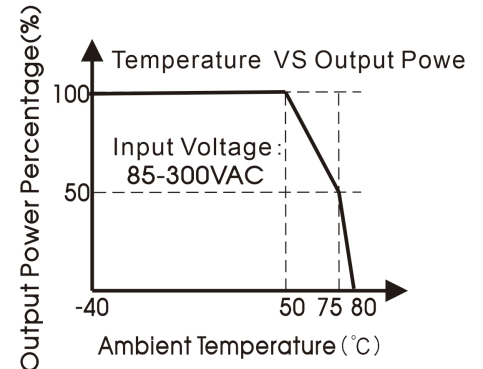

figure3

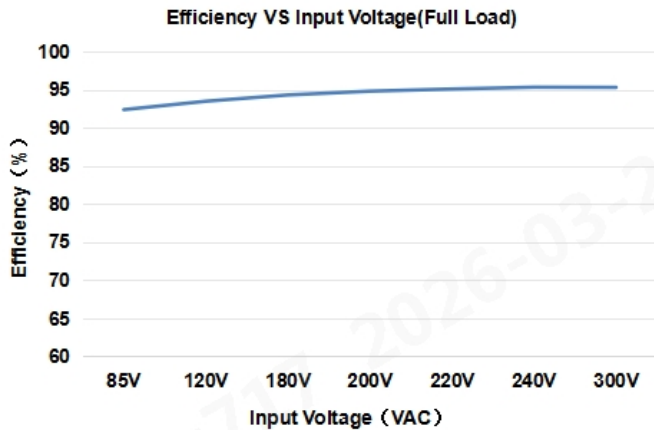

figure4

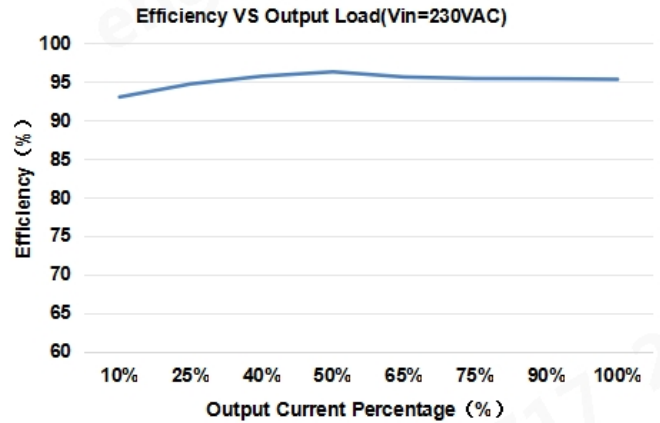
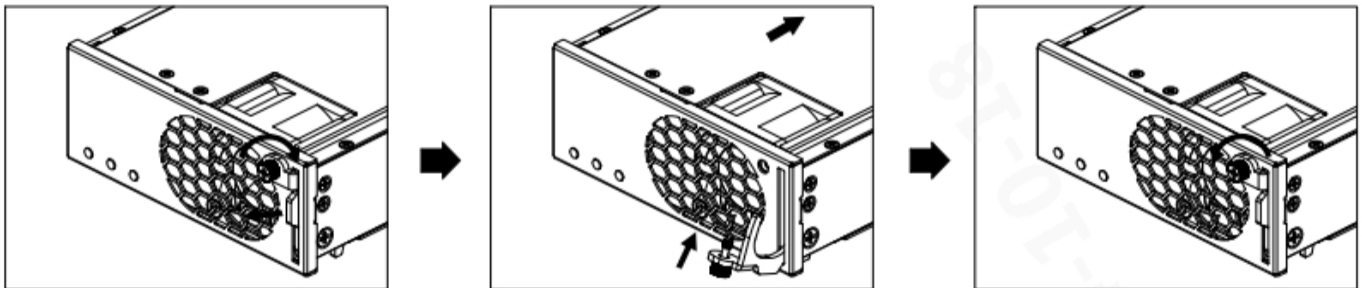

figure5

- Note:
1. When the output of the power module is protected, the output voltage and output current will be limited to the scope of the shadow;
 2. All schematic diagrams are tested at 25°C's environmental temperature, except for other descriptions;
 3. When the input voltage is 85VAC-176VAC reduction application, the demand for the reduction of working temperature is needed;
 4. This product is suitable for use in natural air cooling environment. If you need to use in a closed environment, please consult our FAE staff;
 5. The operating temperature is the same as the ambient temperature, and it is determined according to the air temperature at 2cm above the power module.

Installation Diagram



Step1: Use your hand or a screwdriver to loosen the tight screw and pull the handle outward.

Step2: Gently push the power supply into place and close the handle.

Step3: Secure the handle by tightening the hand screw with your hand or a screwdriver.

Dimensions and Recommended Layout

THIRD ANGLE PROJECTION

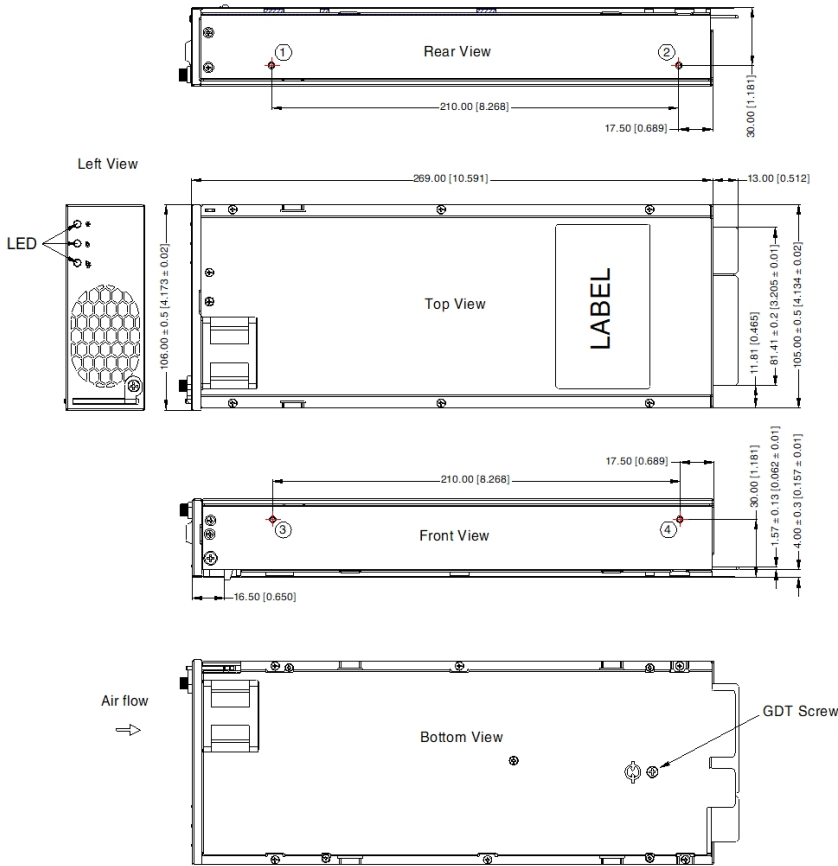

Position	Screw Spec.	Length of locking screw L(max)	Torque(max)
① - ④	M3	5mm	0.4N · m

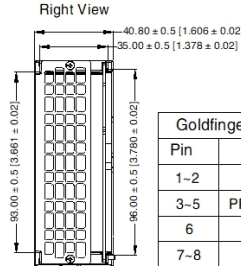
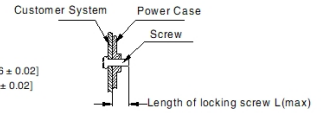

Goldfinger definition		Picture	
Pin	Mark	Top	Bottom
1-2	OUTPUT-		
3-5	PRE-CHARGE		
6	PRESENT		
7-8	OUTPUT+		
9	AC_D2		
10	AC_D1		
11	CANL		
12	CANH		
13-14	PE		
15-16	N		
17-18	L		

Customer connector:
 JONHON DP4SC0504-003 or PJA-061 (Mornsun Accessory) or equivalent
 Customer mounting bracket:
 PJA-069 (Mornsun Accessory)

LED			
Function	Power light	Alarm light	Trouble light
Picture			
Color	Green	Yellow	Red

Note:
 Unit: mm[inch]
 General tolerances: ± 1[± 0.039]

Product extension External connection method-connector (accessories)

Product model: PJA-061

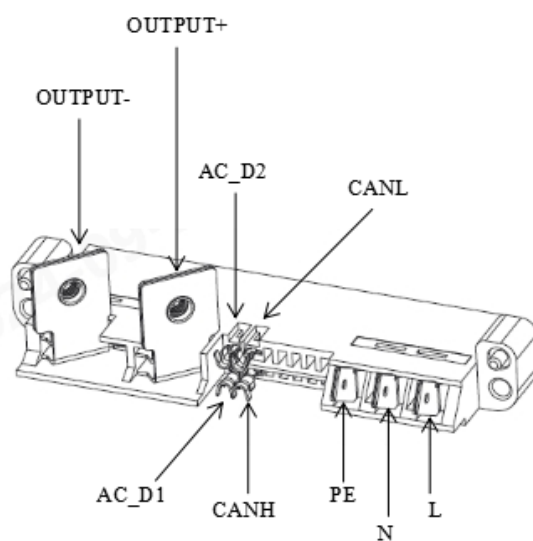

Installation Diagram:

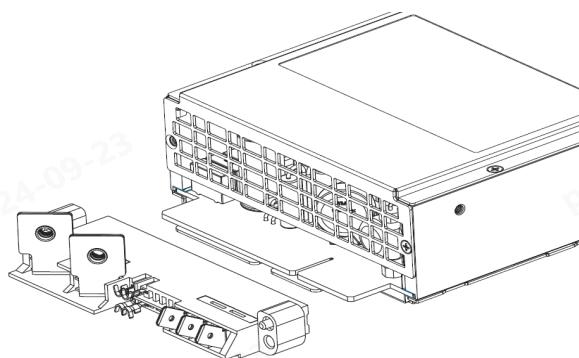

Installation step:

As shown in the figure, insert the PJA-061 connector on the gold finger connector of the product.
This accessory can be purchased separately, if it is necessary to contact the sales engineer.
Special product model: LMR3000-4850, LMR4000-4875

Product extension External connection method-fastener (accessories)

Product model : PJA-069

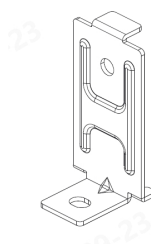

Installation Diagram :

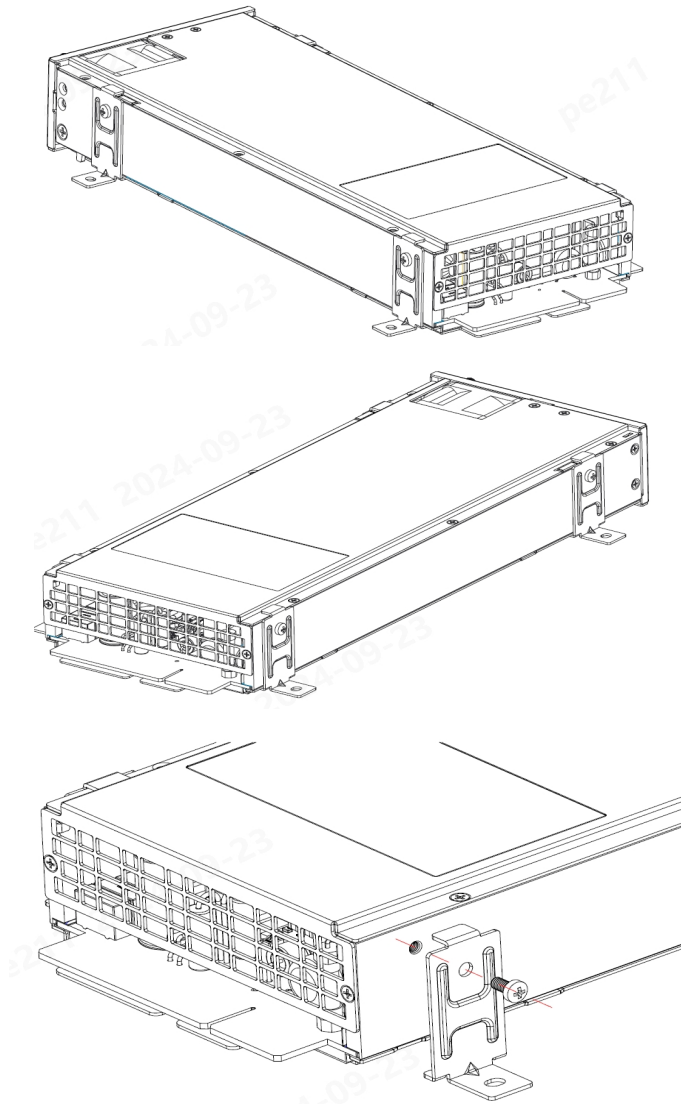

Installation step :

As shown in the figure, PJA-069 is installed on the side position, and the M3 screws in the accessory package are tightened, M3 screw, tight torque 0.45N.m;

This accessory can be purchased separately, if it is necessary to contact the sales engineer;

Special product model: LMR3000-4850、LMR4000-4875.

Note:

1. For additional information on Product Packaging please refer to www.mornsun-power.com. Packaging bag number: 58220767;
2. Unless otherwise specified, parameters in this datasheet were measured under the conditions of $T_a=25^{\circ}\text{C}$, humidity <75%RH with nominal input voltage and rated output load;
3. The room temperature derating of $5^{\circ}\text{C}/1000\text{m}$ is needed for operating altitude greater than 2000m;
4. All index testing methods in this datasheet are based on our company corporate standards;
5. In order to improve the efficiency at high input voltage, there will be audible noise generated, but it does not affect product performance and reliability;
6. We can provide product customization service, please contact our technicians directly for specific information;
7. Products are related to laws and regulations: see "Features" and "EMC";
8. The out case needs to be connected to PE (⊕) of system when the terminal equipment in operating;
9. Our products shall be classified according to ISO14001 and related environmental laws and regulations, and shall be handled by qualified units;
10. The power supply is considered a component which will be installed into a terminal equipment. All EMC tests should be confirmed with the final equipment. Please consult our FAE for EMC test operation instructions.

Mornsun Guangzhou Science & Technology Co., Ltd.

Address: No. 8 Nanyun 4th Road, Huangpu District, Guangzhou, China

Tel: 86-20-38601850

Fax: 86-20-38601272

E-mail: info@mornsun.cn

www.mornsun-power.com

MORNSUN®

MORNSUN Guangzhou Science & Technology Co., Ltd.

2026.5.13-A/2

Page 9 of 9

MORNSUN Guangzhou Science & Technology Co., Ltd. reserves the copyright and right of final interpretation