



FEATURES

- Universal 85 - 277VAC or 120 - 390VDC Input voltage
- Efficiency up to 95.1%
- Operating ambient temperature range: -40°C to +85°C
- 150% peak load
- Active PFC, PF>0.98
- DC OK function
- Double-sided conformal coating, salt-spray proof, explosion-proof
- Operating altitude up to 5000m
- OVC III (design refer to EN62477, 2000m)
- 5 years warranty
- Output short circuit, over-current, over-voltage, over-temperature protection
- Safety according to ATEX, IECEx increased safety type explosion-proof certification
- Meets ANSI/ISA 71.04-2013 G3 corrosion test
- Safety according to IEC/EN/UL/BS EN62368, UL61010, UL508

LIMF240-23BxxG is Mornsun explosion-proof Din-rail power supply featuring with energy saving, high performance, high reliability, high efficiency. With 150% peak load capacity is enough to support heavy loads such as DC motors or capacitive loads, up to 95.1% efficiency can greatly improve power supply reliability and service life. With good EMC performance and compliant with international standards of IEC/EN/UL/BS EN 62368, UL61010, UL508, ANSI/ISA 71.04-2013 for EMC and safety. The power supply meets the "ec" increased safety and "nC" isolation short-circuit n-type explosion-proof certification and is suitable for explosive environment where the equipment protection level is Gc in zone 2. They are widely used in wind power industry, DCS, industrial control equipment, machine control, LED, street light control, security, 5G communication and other fields.

Selection Guide

Certification	Part No.*	Output Power (W)	Nominal Output Voltage and Current (Vo/Io)	Output Voltage Adjustable Range (V)	Efficiency at 230VAC (%) Typ.	Max. Capacitive Load (μF)
--	LIMF240-23B12G	192	12V/16A	12.0-14.0	93.5	100000
	LIMF240-23B24G	240	24V/10A	24.0-28.0	95.1	50000

Note: 1. *When the output voltage rises, the total power of the product should not exceed the rated power;
2. *This product is suitable for indoor use, if it is used in outdoor environment, please consult our FAE.

Input Specifications

Item	Operating Conditions	Min.	Typ.	Max.	Unit
Input Voltage Range	Rated input (Certified voltage)	100	--	240	VAC
	AC input	85	--	277	
	DC input	120	--	390	VDC
Maximum Input Voltage	Lasts for 2h without damage	--	--	305	VAC
Input Voltage Frequency		47	--	63	Hz
Input Current	115VAC	--	--	3	A
	230VAC	--	--	1.5	
Inrush Current	115VAC	--	14	--	
	230VAC	--	26	--	
Inrush Current Integral (I²t)	115VAC	--	0.25	--	A²s
	230VAC	--	0.867	--	

Power Factor	Rated load	115VAC	--	0.98	--	--
		230VAC	--	0.96	--	
THD	230VAC, rated load		--	3	--	%
Start-up Delay Time	115VAC/230VAC, rated load		--	520	--	ms
Rise Time			--	19	--	
Input Fuse	Built-in fuse		--	8	--	A
DC OK Signal	Resistive load		30VDC/1A Max.			
Hot Plug			Unavailable			

Output Specifications

Item	Operating Conditions		Min.	Typ.	Max.	Unit
Output Voltage Accuracy	Full load range		--	±1.0	--	%
Line Regulation	Rated load		--	±0.25	--	
Load Regulation	0% - 100% load		--	±0.5	--	
Power Consumption*	230VAC, rated load	12V	--	11.5	--	W
		24V	--	10.8	--	
Ripple & Noise*	20MHz bandwidth (peak-to-peak value)	12V	--	--	150	mV
		24V	--	--	100	
Hold-up Time			--	37	--	ms
Over-current Protection*	115VAC/230VAC		110	150	--	%
Short Circuit Protection*			Hiccup mode, constant current works 1s (Typ.), turn off 10s, continuous, self-recovery			
Over-voltage Protection			12V	≤ 18VDC (Hiccup, self-recovery)		
	24V	≤ 35VDC (Hiccup, self-recovery)				
Over-temperature Protection*	230VAC, rated load	Over-temperature protection start	--	--	105	°C
		Over-temperature protection release	60	--	--	

- Note: 1. *The "Tip and barrel method" is used for ripple and noise test, output parallel 47uF electrolytic capacitor and 0.1uF ceramic capacitor, please refer to Enclosed Switching Power Supply Application Notes for specific information;
 2. *Over-temperature protection: Put the product into a high temperature box. After the ambient temperature stabilizes, increase the temperature slightly (3°C to 5°C), and the load remains unchanged. After the product reaches thermal equilibrium, increase the temperature until the product triggers over-temperature protection;
 3. *Power consumption curve, over-current protection mode and short circuit protection mode see product characteristic curve.

General Specifications

Item	Operating Conditions		Min.	Typ.	Max.	Unit
Isolation Test*	Input - ⊕	Electric strength test for 1min., leakage current <5mA (Isolation Test need to remove the screw at the mark shall ⊕ *)	2500	--	--	VAC
	Input - output		4000	--	--	
	Output - ⊕		500	--	--	
	DC OK - output		500	--	--	
Insulation Resistance	Input - ⊕	Environment temperature: 25±5°C Relative humidity: < 95%, non-condensing Test voltage: 500VDC	500	--	--	MΩ
	Input - output		500	--	--	
	Output - ⊕		500	--	--	
Operating Temperature			-40	--	+85	°C
Storage Temperature			-40	--	+85	
Operating Humidity	Non-condensing		5	--	95	%RH
Storage Humidity			5	--	90	
Switching Frequency*	PFC		40	--	130	kHz
	DC-DC		50	--	130	
	Auxiliary source		--	65	--	

Power Derating	Operating temperature derating	-40°C to -25°C	3.34	--	--	% / °C
		+60°C to +70°C	3.75	--	--	
		+70°C to +85°C	3.17	--	--	
	Input voltage derating	85VAC - 100VAC	1	--	--	% / VAC
Leakage Current	240VAC	Input - output	<0.5mA			
		Input - ⊕	<0.88mA			
Safety Standard		Design refer to IEC/UL/EN/BS EN62368-1, UL61010-1, UL508, IEC60079-0, IEC60079-7, IEC60079-15, ANSI/ISA 71.04-2013				
Safety Class		CLASS I				
MTBF	MIL-HDBK-217F@25°C	980,000 h				
	MIL-HDBK-217F@40°C	878,000 h				
Pollution degree		2				
Warranty	Ambient temperature: <40°C	5 years				
High and Low Voltage Crossing	Test with Mornsun P/N: LUPS20-24F-N	NB/T 31111-2017				
<p>Note: 1. *The gas discharge tube built into the device effectively protects the power supply against damage by asymmetric disturbance variables (eg EN 61000-4-5). Each power supply continuous withstand voltage test will cause extremely high load to the power supply. Therefore, unnecessary loading or damage to the power supply due to excessive test voltage should be avoided. If necessary, disconnect the gas discharge tube built into the device to use a higher test voltage. After successful completion of the test, reconnect the gas discharge tube. Please refer to the "LIMF240-23Bxx Installation and Application Manual" for specific operation methods;</p> <p>2. *The power supply has three converters with three different switching frequencies. Auxiliary source frequency is nearly constant, other switching frequencies depend on input voltage and load.</p>						

Environmental Characteristics

Item	Operating Conditions	Standard
High and Low Temperature Working	+85°C, -40°C	GB2423.1, IEC60068-2-1
Sinusoidal Vibration	10 - 500Hz, 2g, three directions of X, Y, Z axis	GB2423.10, IEC60068-2-6
Salt Mist	+35°C, 5%NaCl, 48h	GB2423.17, IEC60068-2-11
Alternating Hot and Humid	+25°C, 95%RH - +60°C, 95%RH	GB2423.4, IEC60068-2-30
Low Temperature Storage	-40°C	GB2423.1, IEC60068-2-1
High Temperature Storage	+85°C	GB2423.2, IEC60068-2-2
High Temperature Aging	+60°C	GB2423.2, IEC60068-2-2
Normal Temperature Aging	+25°C	GB2423.1, IEC60068-2-1
Temperature Shock	-40°C to +85°C	GB2423.22, IEC60068-2-14
Temperature Cycle	-25°C to +60°C	GB2423.22, IEC60068-2-14
Hot and Humid	+85°C, 85%RH	GB2423.50, IEC60068-2-67
High Temperature Elevation	+60°C, 54KPa	GB2423.26, IEC60068-2-41
Low Temperature Elevation	-25°C, 54KPa	GB2423.25, IEC60068-2-40
Constant Humid and Hot	+40°C, 95%RH	GB2423.3, IEC60068-2-78
Random Vibration	5 - 10Hz, ASD 0.3 - 10g ² /Hz, three directions of X, Y, Z axis	GB/T 4798.2-2008, IEC60721-3-2
Sinusoidal Vibration Response	10 - 150Hz, 1g, three directions of X, Y, Z axis	GB/T 11287-2000, IEC60255-21-1
Sinusoidal Vibration Endurance Test		
Sinusoidal Impulse Response	15g, pulse duration 11ms, three times in each direction of X, Y, Z axis	GB/T 114537-1993, IEC60255-21-2
Sinusoidal Impact Endurance Test		
Packaging Drop	1m, one corner, three edges and six sides	GB2423.8, IEC68-2-32

Mechanical Specifications

Case Material	Metal (AL5052, SUS304)
Dimensions	124.00mm x 121.00mm x 48.00mm
Weight	870g (Typ.)
Cooling Method	Free air convection

Electromagnetic Compatibility (EMC)

EMC	Item	Standard	Range	Judge	
Emissions	CE (Input port)	CISPR32 EN55032	150K - 30MHz	CLASS B	
	CE (Output port)	CISPR32 EN55032	150K - 30MHz	CLASS A	
	RE	CISPR32 EN55032	30MHz - 1GHz	CLASS B	
	Harmonic current	IEC/EN61000-3-2		CLASS A and CLASS D	
	Voltage flicker	EN61000-3-3			
Immunity	ESD	IEC/EN61000-4-2	Contact ±8KV/Air ±15KV	perf. Criteria A	
	RS	IEC/EN61000-4-3	20V/m		
	EFT (Input port)	IEC/EN61000-4-4	±4KV		
	EFT (Output port)	IEC/EN61000-4-4	±2kv		
	Surge (Input port)	IEC/EN61000-4-5	L to N ±3KV/L or N to PE ±6KV		
	Surge (Output port)	IEC/EN61000-4-5	line to line ±1KV/line to ground ±2KV		
	MS	IEC/EN61000-4-8	30A/m		
	AC power port harmonics	IEC61000-4-13	CLASS 3		
	Harmonic and network signal				
	Low frequency immunity				
	CS	IEC/EN61000-4-6	0.15 - 80MHz 20Vr.m.s		
	Voltage dips	IEC/EN61000-4-11	0% of 115Vac, 0Vac, 1 cycle		perf. Criteria A
			40% of 115Vac, 46Vac, 10/12 cycle		perf. Criteria C
70% of 115Vac, 80.5Vac, 25/30 cycle			perf. Criteria A		
0% of 230Vac, 0Vac, 1 cycle			perf. Criteria A		
40% of 230Vac, 92Vac, 10/12 cycle			perf. Criteria A		
70% of 230Vac, 161Vac, 25/30 cycle			perf. Criteria A		
Voltage interruption	IEC/EN61000-4-11	0% of 200Vac, 0Vac, 250/300 cycle	perf. Criteria C		

Note: perf. Criteria:

A: The equipment shall continue to operate as intended without operator intervention;

B: After the test, the equipment shall continue to operate as intended without operator intervention;

C: Loss of function is allowed, provided the function is self-recoverable, or can be restored by the operation of the controls by the user in accordance with the manufacturer's instructions.

Product Characteristic Curve

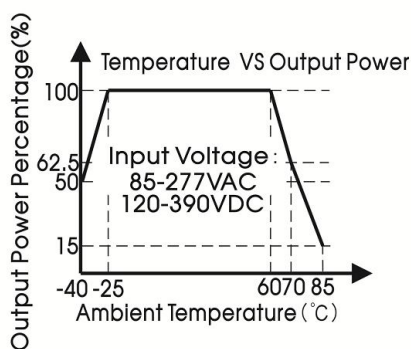

Figure 1

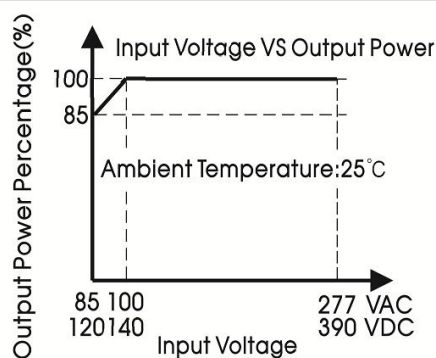

Figure 2

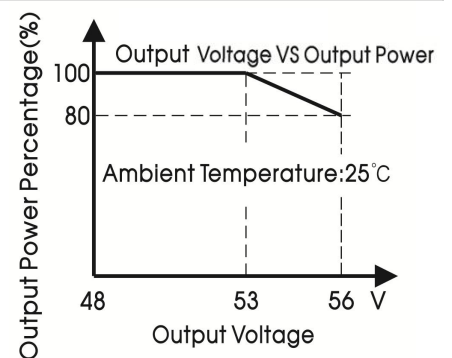

Figure 3

Output voltage VS Output current curve (Typ.)

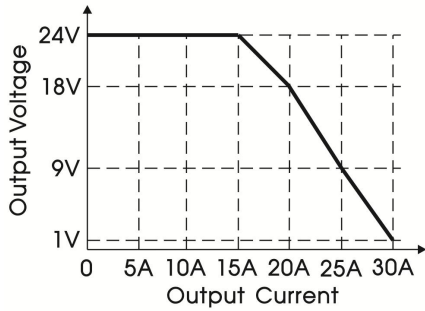

Figure 4

DC OK behavior curve (Typ.)

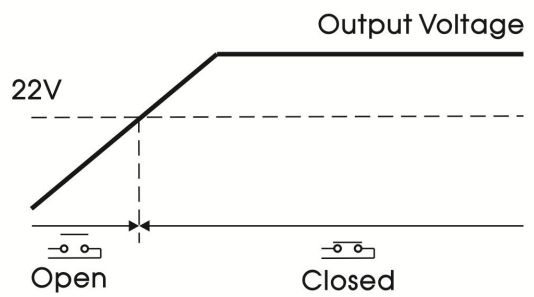

Figure 5

Over-current protection curve (Typ.)

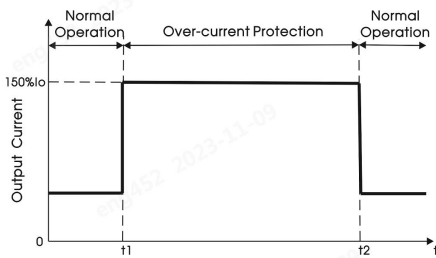

Figure 6

Short circuit protection curve (Typ.)

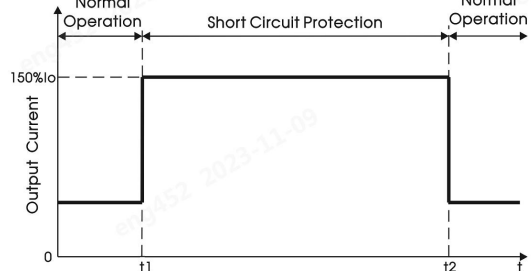

Figure 7

PF Vs Input Voltage (Full Load)

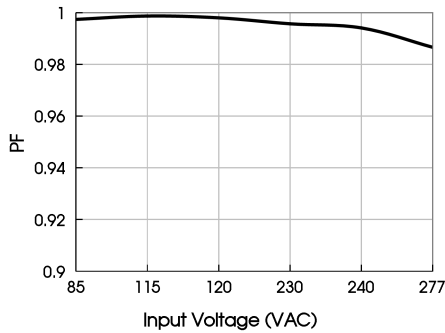

Figure 8

PF Vs Output Load (Vin=230VAC)

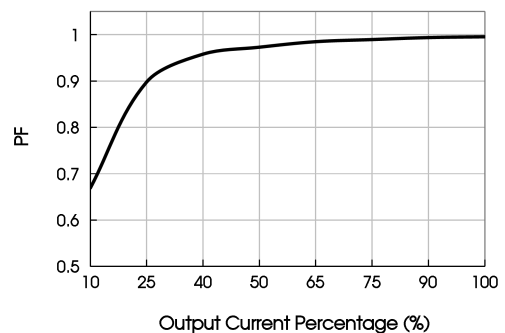

Figure 9

THD Vs Input Voltage (Full Load)

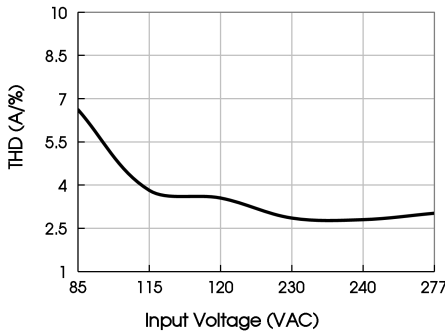

Figure 10

THD Vs Output Load (Vin=230VAC)

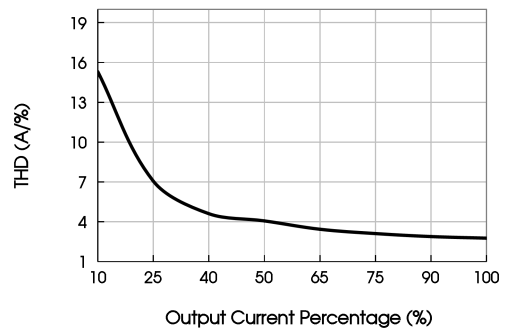
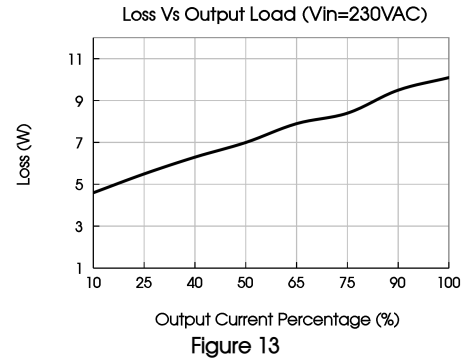
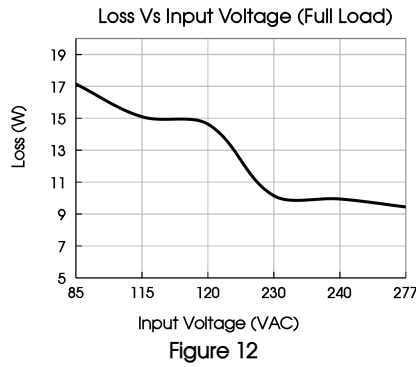
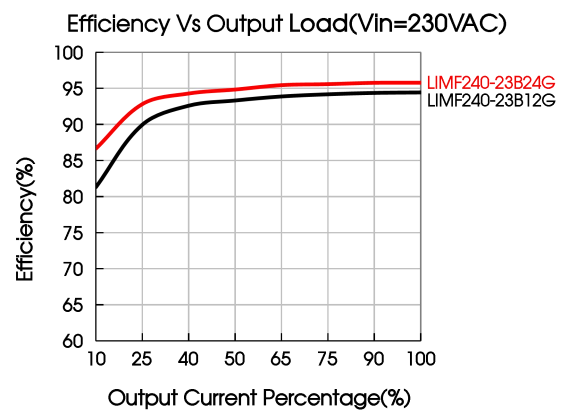
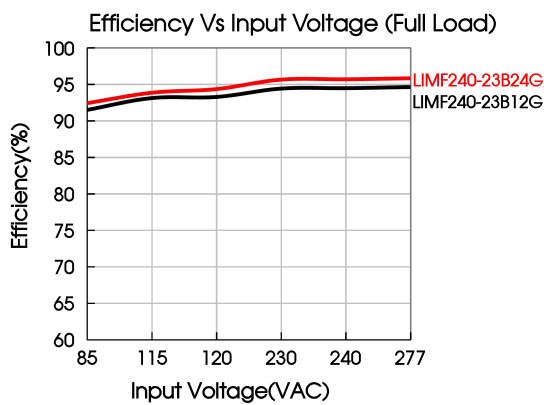

Figure 11



- Note: 1. All curves are for 24V output, measured at input 230VAC, 50Hz, output I_o , ambient temperature 25°C, unless otherwise stated.
 2. With an AC input voltage between 85-100VAC and a DC input between 120-140VDC the output power must be derated as per the temperature derating curves;
 3. This product is suitable for applications using natural air cooling, for applications in closed environment please consult Mornsun FAE.



Installation Diagram

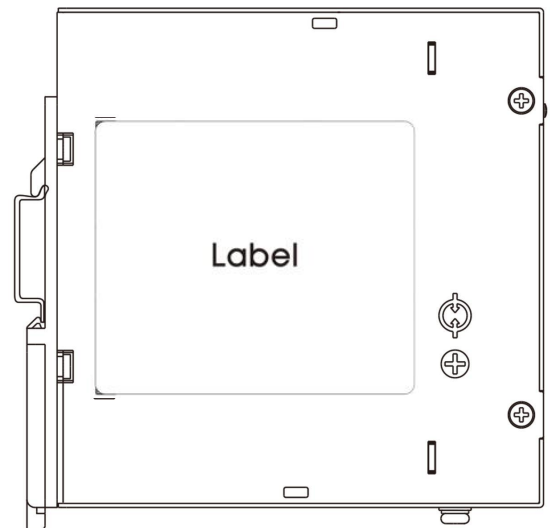
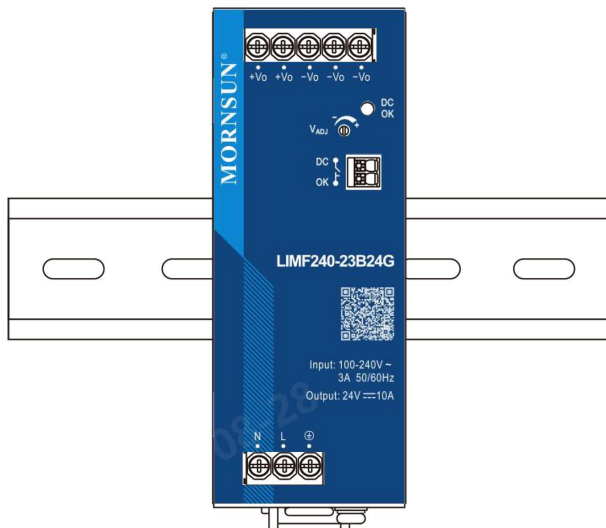

Bill Of Material		
1	Product	1 PCS
2	Phillips screwdriver Slotted screwdriver	1 PCS
3	TS35/7.5 or TS35/15	1 PCS
4	24-10AWG wire	/ PCS
	The content is for reference only. Regarding the actual wire diameter and tightening torque, refer to the dimensional drawing.	



Product

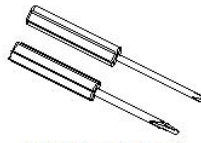

Phillips screwdriver
Slotted screwdriver
Diameter : 3mm

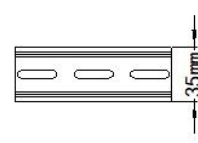

TS35/7.5 or TS35/15

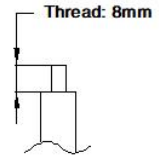

24-10AWG wire

Installation steps ①-②

① Clamp the buckle of the product into the TS35 DIN rail.



② Push the product vertically towards the TS35 DIN rail until hearing the sound of the buckle snapping into it.

Disassembly steps ③-④

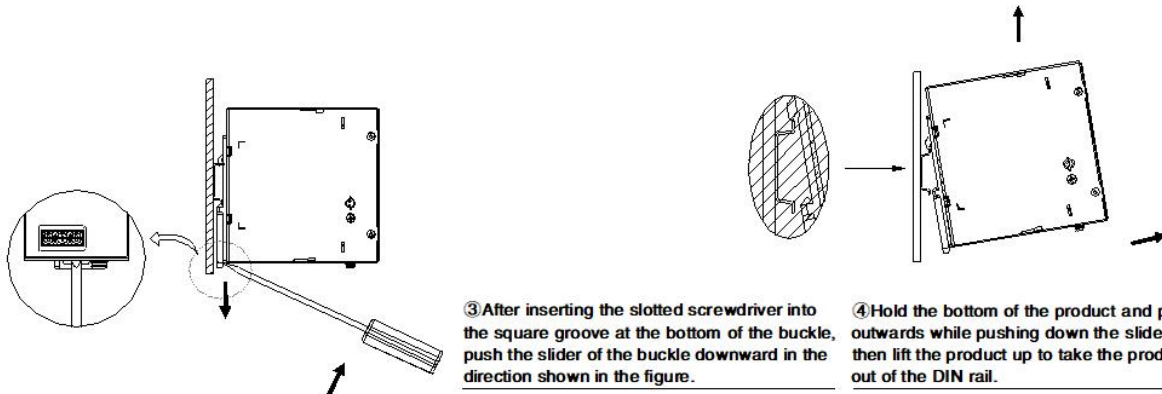

Wiring / Unwiring Steps ⑤-⑥

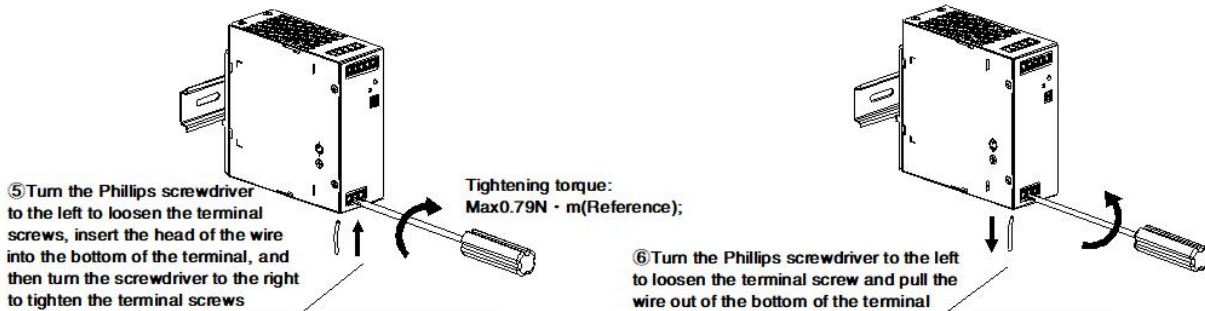

Tightening torque:
Max0.79N · m(Reference);

Note: Keep the following installation clearances: 20mm on top, 20mm on the bottom, 5mm on the left and right sides are recommended when the device is loaded permanently with more than 50% of the rated power. Increase this clearance to 15mm in case the adjacent device is a heat source (e.g. another power supply).

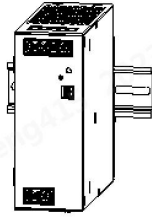
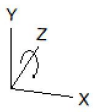

Rotate the installation position
(0° Z-Axis)

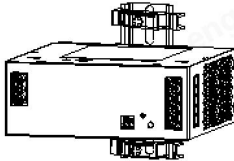
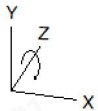
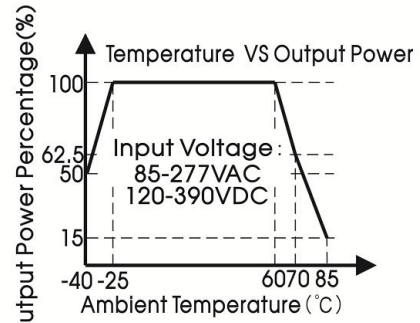

Rotate the installation position
(90° Z-Axis)

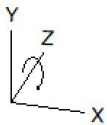
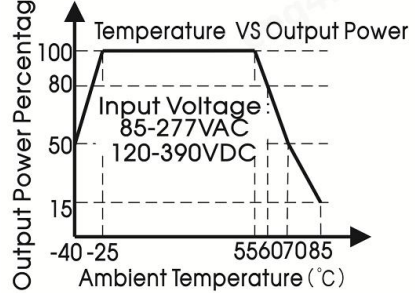

Rotate the installation position
(180° Z-Axis)

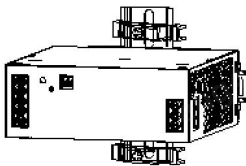
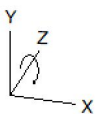
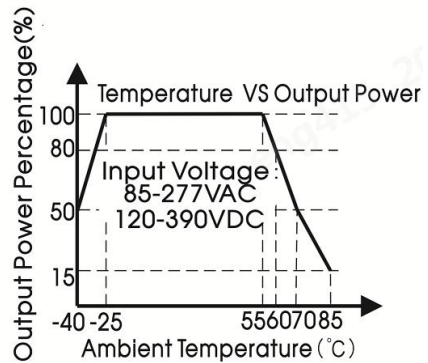

Rotate the installation position
(270° Z-Axis)

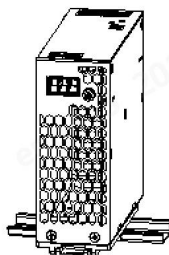
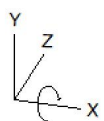
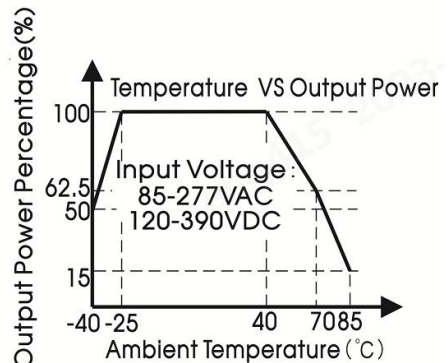

Rotate the installation position
(270° X-Axis)

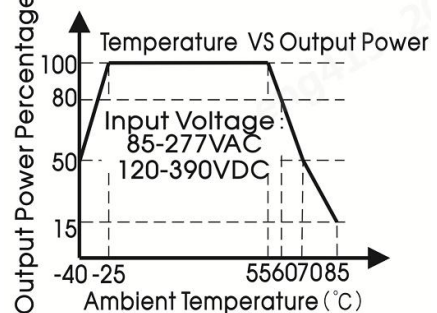

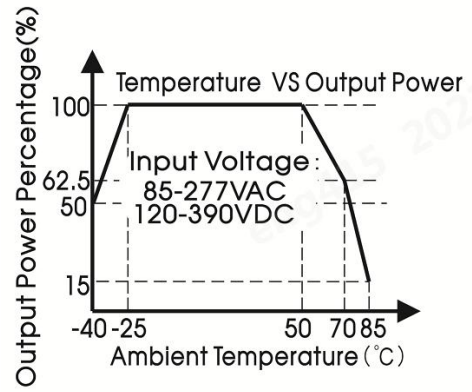
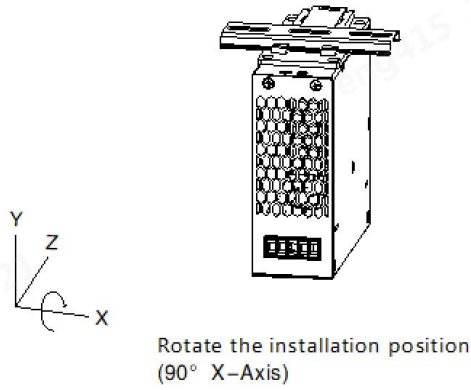

Dimensions and Recommended Layout

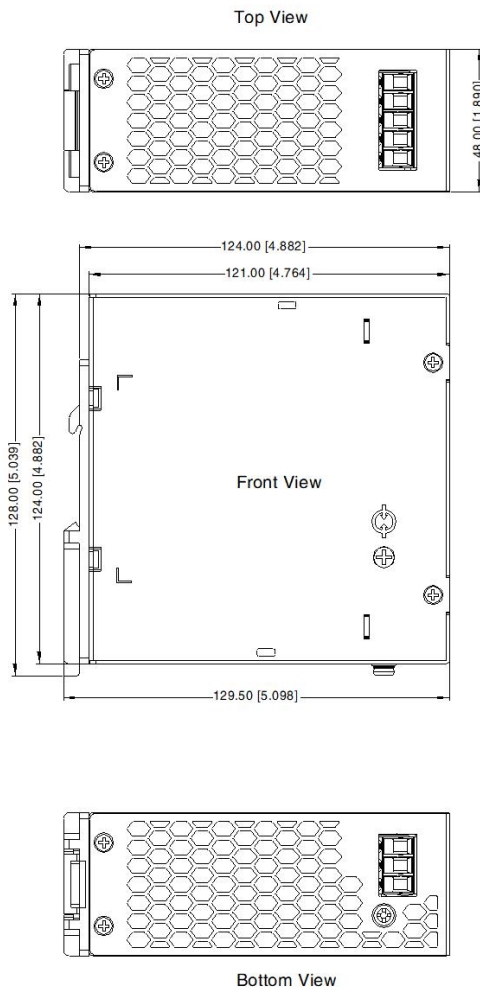

THIRD ANGLE PROJECTION

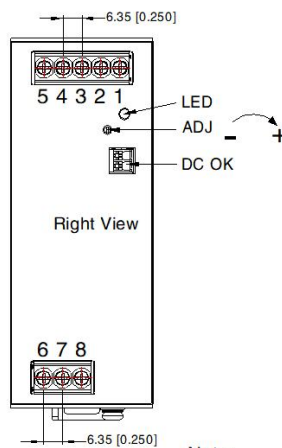

Pin-Out	
Pin	Mark
1	-Vo
2	-Vo
3	-Vo
4	+Vo
5	+Vo
6	AC(N)
7	AC(L)
8	

Note:
 Unit: mm[inch]
 LED: Output status indicator LED
 ADJ: Output adjustable resistor
 Wire range: Input: 26-10AWG(12-10AWG for pin8)
 Output: 12V: 12-10AWG
 24V: 16-10AWG
 DC OK: 24-16AWG
 Connector tightening torque: 0.5N · m ± 10%
 Mounting rail: TS35, rail needs to connect safety ground
 General tolerances: ± 1.00[± 0.039]



WARNING Risk of electrical shock, fire, personal injury or death:

AVERTISSEMENT AVERTISSEMENT Risque de choc électrique, d'incendie, de blessures corporelles ou de décès :

1. Do not use the power supply without proper grounding (Protective Earth). Use the terminal on the input block for earth connection and not one of the screws on the housing;
N'utilisez pas l'alimentation électrique sans mise à la terre appropriée (Terre protectrice). Utilisez le terminal sur le bloc d'entrée pour la connexion terrestre et non pas une des vis sur le boîtier;
2. Turn power off before working on the device, protect against inadvertent re-powering;
Éteignez l'alimentation avant de travailler sur l'appareil, protégez-vous contre la réenergisation accidentelle;
3. Make sure that the wiring is correct by following all local and national codes;
Assurez-vous que le câblage est correct en suivant tous les codes locaux et nationaux;
4. Do not modify or repair the unit;
Ne modifiez pas ou ne réparez pas l'appareil;
5. Do not open the unit as high voltages are present inside;
Ne modifiez pas ou ne réparez pas l'appareil;
6. Use caution to prevent any foreign objects from entering the housing;
Faire preuve de prudence pour empêcher les objets étrangers d'entrer dans le logement;
7. Do not use in wet locations or in areas where moisture or condensation can be expected;
Faire preuve de prudence pour empêcher les objets étrangers d'entrer dans le logement;
8. Do not touch during power-on, and immediately after power-off, hot surfaces may cause burns; 
Ne touchez pas pendant l'alimentation et, immédiatement après l'alimentation, les surfaces chaudes peuvent causer des brûlures.
9. For ambient temperature $\leq 60^{\circ}\text{C}$, use $\geq 90^{\circ}\text{C}$ - copper wire only; for ambient temperature $>60^{\circ}\text{C}$ to 85°C , use $\geq 105^{\circ}\text{C}$ - copper wire only; use only wires with a minimum dielectric strength of 300V (input) and 60V (output);
Température ambiante $\leq 60^{\circ}\text{C}$, utiliser $\geq 90^{\circ}\text{C}$ - seulement fils de cuivre; Température ambiante $>60^{\circ}\text{C}$ et 85°C , utiliser $\geq 105^{\circ}\text{C}$ - seulement fils de cuivre; Uniquement pour l'utilisation de fils de cuivre d'une résistance d'isolation minimale de 300V (d'entrée) et 60V (de sortie).

Note:

1. For additional information on Product Packaging please refer to www.mornsun-power.com. Packaging bag number: 58220282;
2. Unless otherwise specified, parameters in this datasheet were measured under the conditions of $T_a=25^{\circ}\text{C}$, humidity $<75\%$ RH with nominal input voltage and rated output load;
3. The room temperature derating of $5^{\circ}\text{C}/1000\text{m}$ is needed for operating altitude greater than 2000m;
4. All index testing methods in this datasheet are based on our company corporate standards;
5. In order to improve the efficiency at high input voltage, there will be audible noise generated, but it does not affect product performance and reliability;
6. We can provide product customization service, please contact our technicians directly for specific information;
7. Products are related to laws and regulations: see "Features" and "EMC";
8. The out case needs to be connected to PE (\perp) of system when the terminal equipment in operating;
9. The output voltage can be adjusted by the ADJ, clockwise to increase;
10. Our products shall be classified according to ISO14001 and related environmental laws and regulations, and shall be handled by qualified units.

Mornsun Guangzhou Science & Technology Co., Ltd.

Address: No. 8 Nanyun 4th Road, Huangpu District, Guangzhou, China

Tel: 86-20-38601850

Fax: 86-20-38601272

E-mail: info@mornsun.cn

www.mornsun-power.com