

Ultra-wide input, non-isolated, buck-boost single output

## FEATURES



- Ultra-wide input voltage range: 9 - 60VDC
- Output voltage range: 0 - 60VDC
- High efficiency up to 97.8%
- Reverse Current Protection
- Protections: input under-voltage, input over-voltage, output over-voltage, short-circuit, output over-current, over-temperature
- Operating ambient temperature range: -40°C to 100°C (case temperature)
- Industry standard half-Brick package and pin-out

CE Report UKCA Report Patent Protection RoHS



EN 62368-1 BS EN62368-1

KUB6060QB(F)-30AxG is high efficiency switching regulators. It features ultra-wide input range of 9-60VDC, adjustable output voltage range of 0-60VDC, operating temperature of -40°C to +100°C, input over-voltage and under-voltage protection, output short-circuit and output over-voltage, over-current, over-temperature protection, remote control, output voltage regulation and remote compensation (S- option only), current monitor (C-option only) and other functions. It is widely used in robotics, communications, battery management, DC-DC distributed power supply and other occasions.

## Selection Guide

Certification	Part No.	Input		Output	
		Nominal (Range) (VDC)	Current <sup>②</sup> (A) Max.	Voltage (Range) (VDC)	Current <sup>②</sup> (A) Max.
EN/BS EN	KUB6060QB(F)-30ASG KUB6060QB(F)-30ACG	9-60	30	0-60	30

Note:  
 ① When  $V_{in} > V_o$ , the output current does not exceed 30A; when  $V_{in} \leq V_o$ , the input current does not exceed 30A;  
 ② The KUB6060QB(F)-30ASG has remote sense (S-option only), the KUB6060QB(F)-30ACG has Adjustable current limit with current monitor (C-option only);  
 ③ KUB6060QBF-30ASG and KUB6060QBF-30ACG are both equipped with F-Type heat sink packaging.

## Typical input-output Efficiency

Input Voltage(VDC)	Output Voltage(VDC)	Output Current(A)	Power(W)	Efficiency (%)
				Typ.
60	48	30	1440	97.3
	48	25	1200	97.5
	48	12.5	600	97.8
48	24	30	720	95
	24	25	600	96
	24	12.5	300	96
24	12	30	360	93
	12	25	300	94
	12	12.5	150	95
12	48	7.5	360	91
	48	6.25	300	92
	48	3.13	150.24	93
60	48	30	1440	97.3

Input Specifications

Item	Operating Conditions	Min.	Typ.	Max.	Unit
Input Current (no-load)	Vin=28V, Vout=12V, Io=0A	--	115	--	mA
	Vin=28V, Vout=24V, Io=0A	--	115	--	
	Vin=28V, Vout=48V, Io=0A	--	210	--	
Reflected Ripple Current	Vin=48V, Vout=24V, Io=30A	--	150	--	mA
Surge Voltage (1sec. max.)	1sec. Max.Non-Operating	--	--	80	VDC
Start-up Voltage		--	8	9	
Under-voltage Protection		4.5	5	--	VDC
Over-voltage Protection	self-recovery	--	65	--	
Input Filter		Pi filter			
Hot Plug		Unavailable			
Input Reverse Polarity Protection		Unavailable			
Input Current Limit		--	30	33	A
Ctrl	Module on	Ctrl pin pulled -VIN or pulled low (0-1VDC)			
	Module off	Ctrl pin open or pulled TTL to high(1.5-5.5VDC)			
	Input current when off	--	2	--	mA

Output Specifications

Item	Operating Conditions	Min.	Typ.	Max.	Unit
Output voltage accuracy <sup>①</sup>	3.3V-60Vo 5%~100%Io	KUB6060QB(F)-30AxG		$\pm 100\text{mV} \pm 2\% \cdot \text{Vout} - 2\% \cdot \text{Vout} \cdot \text{Iout} / \text{Iomax}$	
Load Regulation	Nominal input voltage, 5%Io-100%Iomax	KUB6060QB(F)-30AxG		$-2\% \cdot \text{Vout} \cdot \text{Iout} / \text{Iomax}$ (typ.)	
Transient Response Deviation	Vin=28V, Vout=12V, 25% load step change, 0.1A/uS	--	1000	--	mV
	Vin=28V, Vout=48V, 25% load step change, 0.1A/uS	--	1600	--	
Transient Recovery Time	Vin=28V, Vout=12V, 25% load step change, 0.1A/uS	--	400	--	uS
	Vin=28V, Vout=48V, 25% load step change, 0.1A/uS	--	800	--	
Temperature Coefficient	Operating temperature -40℃ to +100℃	--	$\pm 0.02$	--	%/℃
Ripple & Noise <sup>②</sup>	20MHz bandwidth, Vin=28V, Vout=12V, Io=30A	--	50	--	mVp-p
	20MHz bandwidth, Vin=28V, Vout=28V, Io=30A	--	200	--	
	20MHz bandwidth, Vin=28V, Vout=48V, Io=9A	--	100	--	
Over-temperature Protection	Maximum surface temperature of the product	--	108	--	℃
Output Over-voltage Protection	Input voltage range, output power range, self-recovery	--	65	--	VDC
Output Current Limit	Input voltage range, output power range	--	30	33	A
Over current & Short-circuit Protection	Input voltage range	constant current			
Iset	Input to set maximum output current	See Iset function for output current adjustment			
	Pin Voltage (floating)	--	2.5	--	VDC
	Adjustable range of output current	0	--	30	A
Vset	Input to set output voltage	See Vset function for output voltage adjustment			
	Pin Voltage (floating)	--	2.5	--	VDC
	Adjustable range of output voltage	0	--	60	VDC
Sense	See part of Remote Sense Application	See Sense function adjustment			
		--	--	105	%Vo

Note:  
 ①When the output voltage is 0-3.3V,it can work in Non-fixed voltage mode;when the load is 0%~5%Io, the output voltage accuracy is  $\pm 100\text{mV} \pm 3\% \cdot \text{Vout}$ ;  
 ②The "parallel cable" method is used for ripple and noise test ;  
 ③test condition: Ta = 25℃, the product surface temperature is less than 100℃

### General Specifications

Item	Operating Conditions	Min.	Typ.	Max.	Unit
Isolation	Input/Output - Shell, Electric Strength Test for 1 minute with a leakage current of 1mA max.	500	--	--	VDC
Operating Temperature <sup>①</sup>	Surface temperature	-40	--	+100	°C
Storage Temperature		-55	--	+125	
Storage Humidity	Non-condensing	5	--	95	%RH
Pin Soldering Resistance	Wave-soldering, max. 10 second	+255	+260	+265	°C
Temperature	Soldering spot is 1.5mm away from case for 10 seconds	--	--	+300	
Pollution Degree		PD 3			
Vibration		10-150Hz, 5g, 0.75mm, 90 Min. along X, Y and Z			
Switching Frequency	Full load, nominal input voltage	--	270	--	kHz
Operating altitude		Altitude: ≤2000m, Atmospheric pressure: 80-110KPa			
MTBF	MIL-HDBK-217F@25°C, 70°C Tbaseplate	--	3200	--	k hours

Note: ① Operating temperature refers to the surface temperature of the product.  
 ② The soldering temperature that the pin can withstand is not the actual set temperature of the soldering iron, but the temperature required for a good solder joint. The actual set temperature by the customer needs to be comprehensively set based on the thickness of the PCB, the size of the copper cladding, the power of the soldering iron, and the selection of the soldering iron tip.

### Mechanical Specifications

Case Material	Aluminum alloy	
Dimensions	KUB6060QB-30AxG	57.9x36.8x12.7mm
	KUB6060QBF-30AxG	57.9x55.88x12.7mm
Weight	KUB6060QB-30AxG	80 g (Typ.)
	KUB6060QBF-30AxG	83 g (Typ.)
Cooling Method	Free air convection    forced convection	

### Electromagnetic Compatibility (EMC)

Emissions	CE	CISPR32/EN55032	CLASS A (see Fig. 4 for recommended circuit)	
	RE	CISPR32/EN55032	CLASS A (see Fig. 4 for recommended circuit)	
Immunity	ESD	IEC/EN 61000-4-2	Contact ±6kV	perf. Criteria B
	RS	IEC/EN 61000-4-3	10V/m	perf. Criteria A
	EFT	IEC/EN 61000-4-4	±2kV (see Fig. 4 for recommended circuit)	perf. Criteria B
	Surge	IEC/EN 61000-4-5	line to line ±2kV (see Fig. 4 for recommended circuit)	perf. Criteria B
	CS	IEC/EN 61000-4-6	10Vr.m.s	perf. Criteria A

Typical Characteristic Curves

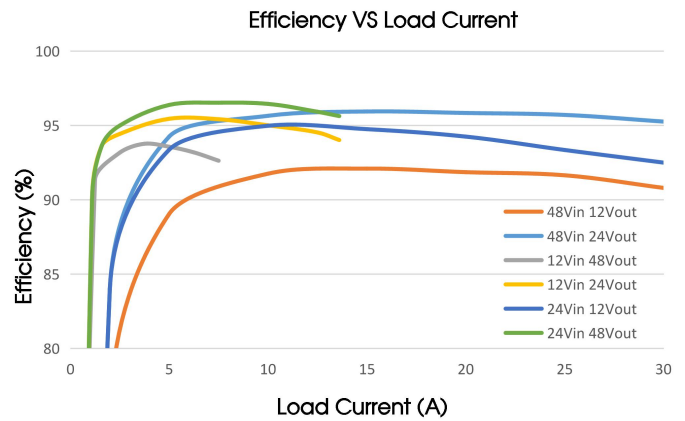
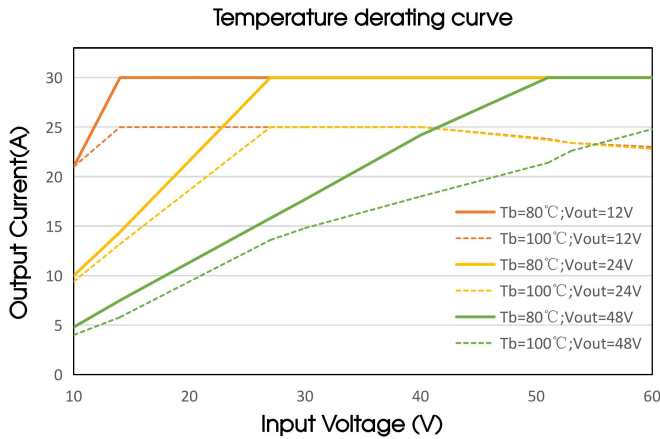

Note: Control the relationship between the maximum output power derating curve and the input voltage when the temperature at point A of the metal base is 80 ° C and 100 ° C

Fig.1

Fig.2

Remote Sense Application (KUB6060QB(F)-30ASG)

1. Remote Sense Connection if not used

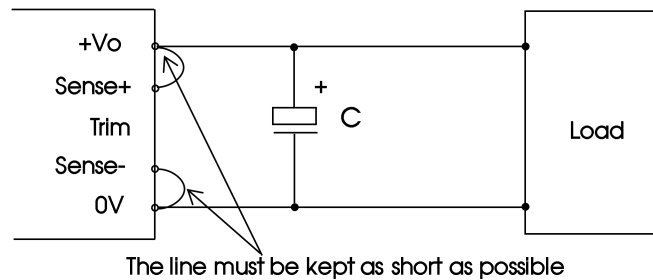

Note:

- (1) If the sense function is not used for remote regulation the user must connect the +Sense to +Vo and -Sense to 0V at the DC-DC converter pins and will compensate for voltage drop across pins only;
- (2) The connections between sense lines and their respective power lines must be kept as short as possible, otherwise they may be picking up noise, interference and/or causing unstable operation of the power module.

2. Remote Sense Connection used for Compensation

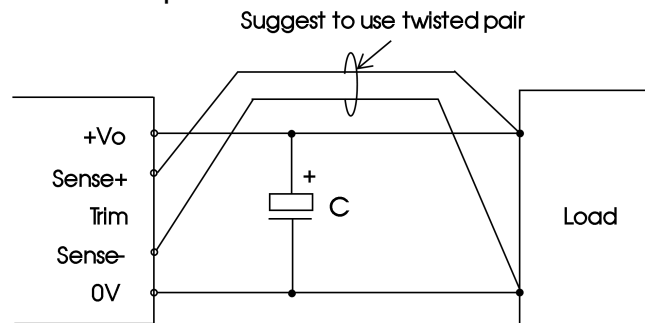

Note:

- (1) Do not exceed the output voltage range when using remote compensation;
- (2) Using remote sense with long wires may cause unstable output, please contact technical support if long wires must be used;
- (3) PCB-tracks or cables/wires for Remote Sense must be kept as short as possible. Twisted pair or shielded wires are suggested for remote compensation and must be kept as short as possible;
- (4) We recommend using adequate cross section for PCB-track layout and/or cables to connect the power supply module to the load in order to keep the voltage drop below 0.3V and to make sure the power supply's output voltage remains within the specified range;
- (5) Note that large wire impedance may cause oscillation of the output voltage and/or increased ripple. Consult technical support or factory for further advice of sense operation.

Design Reference

1. Application circuit

(1) During product testing and application, please follow the recommended test circuit (Figure 3); At least one electrolytic capacitor  $C_{in}$  ( $\geq 470\mu F$ ) is guaranteed to be connected externally to suppress the possible input surge voltage;

(2) If the input terminal of the product is connected in parallel with a circuit with large transient energy (such as a parallel motor drive circuit), the input voltage of the product may be pulled down. At this time, pay attention to the fluctuation of the input voltage of the product, and it is recommended to appropriately increase the capacitance of the electrolytic capacitor  $C_{in}$  at the input terminal to ensure the stability of the input terminal voltage and avoid the situation where the input voltage is lower than the under-voltage protection point and cause the product to restart repeatedly;

(3) If the output end of the product is inductive load (such as relay and motor), it is recommended to increase the output capacitance  $C_{out}$  capacitance within the capacitive load specification and add TVS tubes to filter out voltage spikes;

(4) If the input and output ripple needs to be further reduced,  $C_{in}$  and  $C_{out}$  capacity of external capacitors can be appropriately increased or external capacitors with small series equivalent impedance can be selected.  $C_{out}$  capacity of external capacitors cannot be greater than the maximum capacitive load of products.

(5) When ctrl is used, it can be directly connected to  $-V_{in}$  Pin to achieve output enable control.

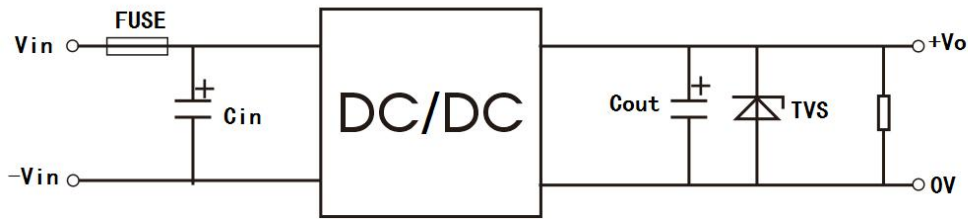

Fig.3

Fuse (optional)	$C_{in}^*$	$C_{out}$	TVS (optional)
40A, 慢熔断	560 $\mu F$ /100V (Electrolytic capacitance)	220 $\mu F$ /100V*2 (Solid-state capacitance) +2.2 $\mu F$ /100V*5 (Ceramic capacitor)	Select based on output

Note:  
\*During the use of external capacitor, attention should be paid to the external environment temperature of the product. Under low temperature, the electrolytic capacitor capacity value should be increased to 2 times of the original parameter at least.

2. EMC compliance circuit

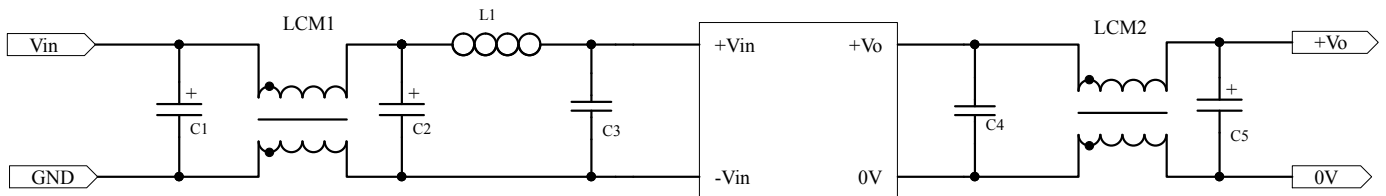

Fig.4 Recommended compliance circuit

C1	LCM1	C2	L1	C3	C4	LCM2	C5
100 $\mu F$ /200V (Electrolytic capacitance)	FL2D-D0-201	560 $\mu F$ /100V (Electrolytic capacitance)	480nH (CODAC A CSM1760)	475/100V*1 6 (Ceramic capacitor)	475/100V*4 (Ceramic capacitor)	FL2D-D0-201	330 $\mu F$ /100V (Solid-state capacitance)

Vset Function for Output Voltage Adjustment

The impedance between the control pin Vset and 0V can adjust the output voltage within the range of 0-60Vdc. The output voltage can be regulated by either an external regulating resistor or an external power supply. When pin Vset is left floating, its voltage is 2.5V, and at this time, the output voltage is 0V. The relationship curve between the Vset voltage and the output voltage Vo is as follows:

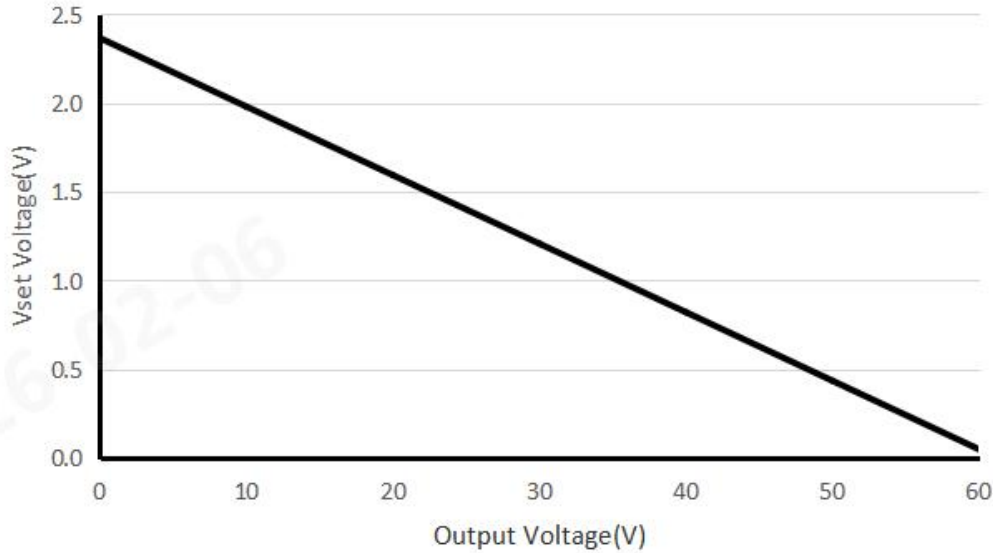

Fig.5 Voltage Vs output voltage

Usage mode 1: external power driver, wiring mode see Fig. 6 on the right

Vset Voltage calculation formula:

$$V_{set} = 2.366 - 0.038V_o$$

Note: Vset represents the desired output voltage, the adjustable range is: 0-60V

Vvset is the voltage of the external power supply, units: V.

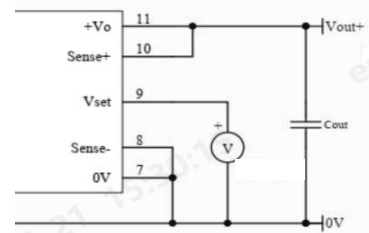

Fig. 6 Vset external power driver wiring diagram

Use mode 2: external adjusting resistor R(Vset), the wiring mode is shown in Fig.7 on the right.

Vset resistance calculation formula:

$$R_{vset} = \frac{aR_2}{R_2 - a}$$

$$a = \frac{2.366 - 0.038V_o}{0.934 + 0.038V_o} R_1$$

Note: Rvset is an external adjusting resistor; units: kΩ

a indicates a user-defined parameter and has no actual meaning.

Vo is the desired output voltage, units: V;

Figure 8 on the right shows the internal Vset circuit of the module, where R1=15kΩ and R2=47kΩ.

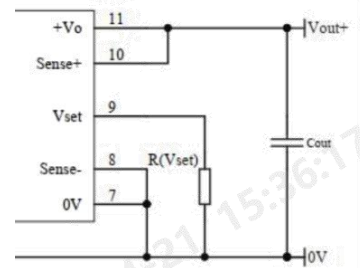

Fig.7 Vset External Adjusting resistance R(Vset) wiring diagram

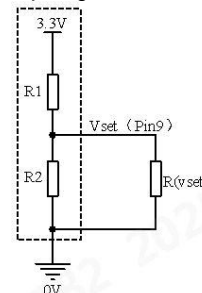

Fig.8 Vset connection diagram inside the module (dashed box)

Vo (V)	3.3	5	12	15	20	24	36	48	55	60
R <sub>res</sub> (kΩ)	97.61	75.99	36.71	28.94	20.39	15.78	7.547	3.145	1.41	0.23

Iset Function for Output Current Adjustment(KUB6060QB(F)-30ACG)

The module contains an output overcurrent protection circuit inside. The impedance between the control pin Iset and 0V can limit the output current to be adjusted within the range of 0-30A. The output current can be adjusted by either adjusting the resistor or driving it with an external power supply. When the Iset pin is suspended, its voltage is 3.3V, and at this time, the default overcurrent point is 115%\*30A.

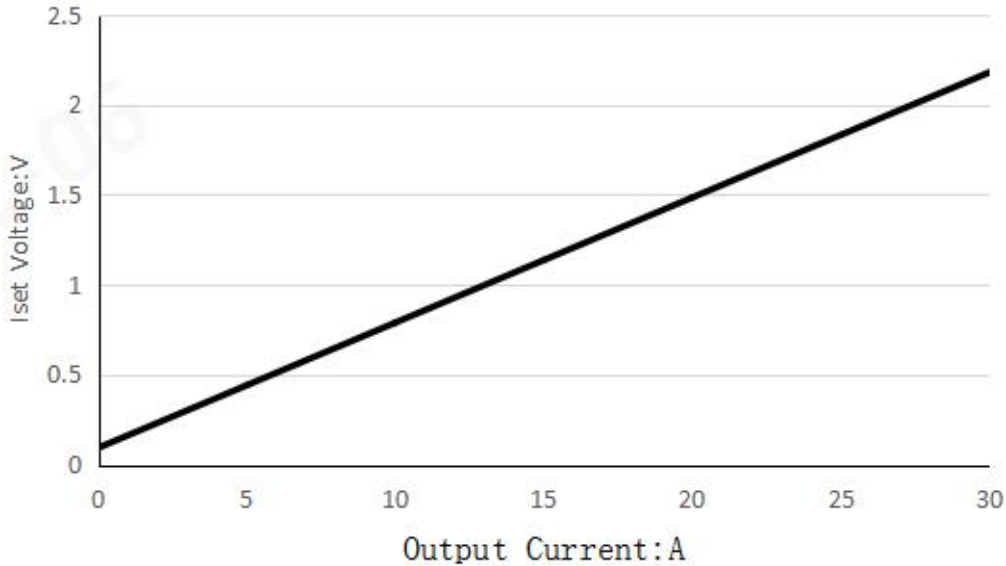

Fig.9 Iset voltage Vs output current

Usage mode 1: external power drive, wiring mode see Fig.10 on the right.

Iset Voltage calculation formula:

$$V_{Iset} = 0.0953 + 0.0695 * Iset$$

Note:Iset is the expected output current, units:A;

Vset is the external power supply, units:V.

Use mode 2: external adjusting resistor R(Vset), wiring mode is shown in Figure 11 on the right.

Iset resistance calculation formula:

$$R_{Iset} = \frac{0.695Iset + 0.953}{3.2047 - 0.0695Iset} (K\Omega)$$

Note:R<sub>Iset</sub> is the external resistance, units:kΩ ;

Iset is the expected output current, units:A.

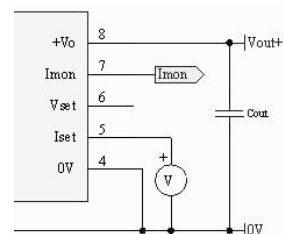

Fig.10 Iset external power driver wiring diagram

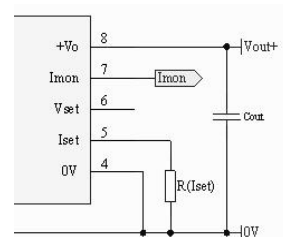

Fig.11 Iset External Adjusting resistance R(Iset) wiring diagram

Current detection design and precautions(KUB6060QB(F)-30ACG)

Usage mode 1: Current detection

I<sub>mon</sub> voltage calculation formula:

$$V_{I_{mon}} = 0.072I_o$$

Note: I<sub>o</sub> is the actual output current, unit:A;  
I<sub>mon</sub> level in a 0V as a reference.  
The capacitive characteristic of the external test equipment connected to this pin must not exceed 1nF.

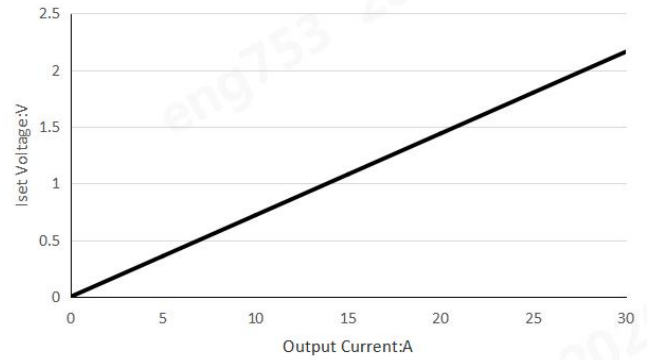

Fig.12 Ishare Vs output current

1. Recommended solution for thermal test

In the process of application, product thermal design can be evaluated by combining product temperature derating curve; Or determine the stable working range of the product by the temperature at point A of the metal shell in the following test diagram. When the temperature at point A is lower than 100°C, it is the stable working range of the product.



2. For additional information please refer to DC-DC converter application notes on [www.mornsun-power.com](http://www.mornsun-power.com)

KUB6060QB-30ASG Dimensions and Recommended Layout

THIRD ANGLE PROJECTION 

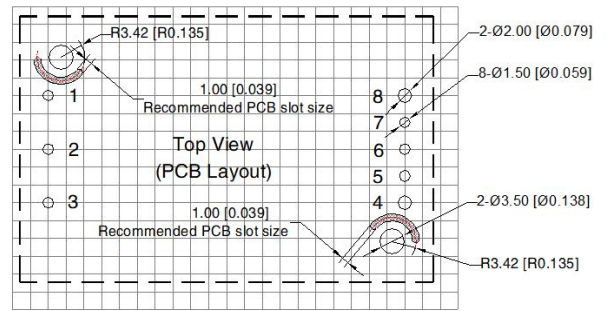
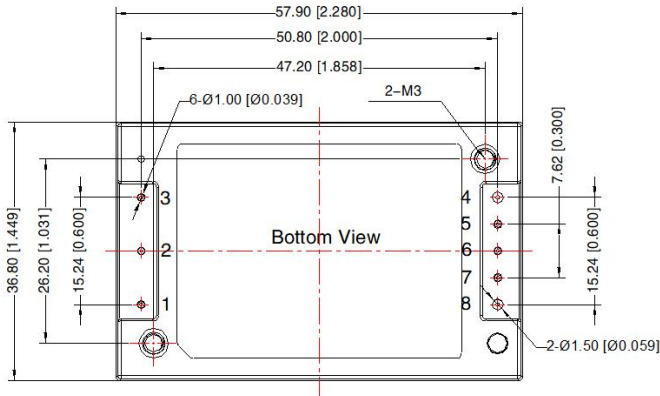
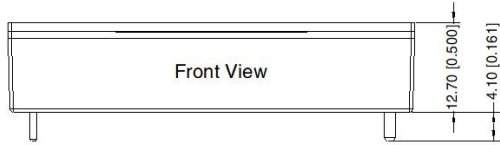

Note: Grid 2.54\*2.54mm

Recommended screw length

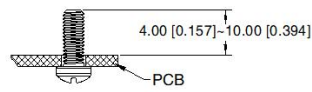

Note:  
Unit: mm[inch]  
Pin1, 2, 3, 5, 6, 7's diameter: 1.00 [0.039]  
Pin4,8's diameter: 1.50 [0.059]  
Pin diameter tolerances:  $\pm 0.10$  [  $\pm 0.004$  ]  
General tolerances:  $\pm 0.50$  [  $\pm 0.020$  ]  
Mounting hole screwing torque:  $0.4 \pm 0.04N \cdot m$

Pin-Out			
Pin	Mark	Pin	Mark
1	+Vin	4	0V
2	Ctrl	5	Sense-
3	-Vin	6	Vset
		7	Sense+
		8	+Vo

KUB6060QBF-30ASG Dimensions and Recommended Layout

THIRD ANGLE PROJECTION 

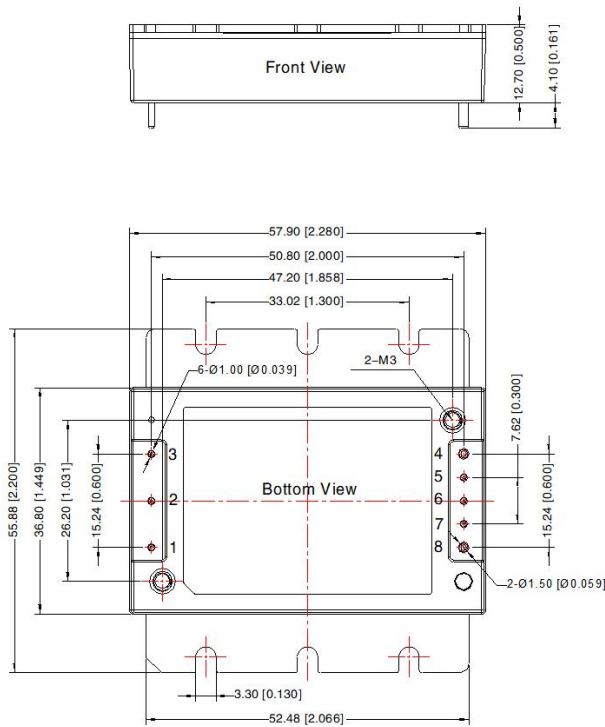

Note:  
Unit: mm[inch]  
Pin1, 2, 3, 5, 6, 7's diameter: 1.00 [0.039]  
Pin4,8's diameter: 1.50 [0.059]  
Pin diameter tolerances:  $\pm 0.10$  [ $\pm 0.004$ ]  
General tolerances:  $\pm 0.50$  [ $\pm 0.020$ ]  
Mounting hole screwing torque:  $0.4 \pm 0.04\text{N} \cdot \text{m}$

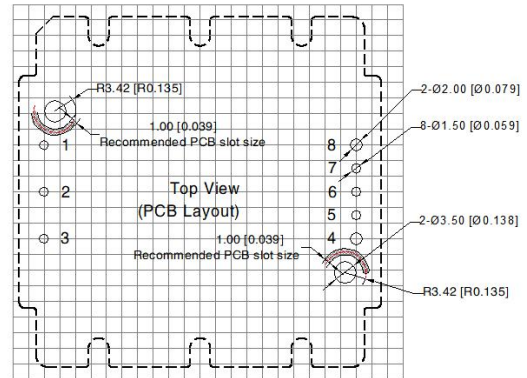

Note: Grid 2.54\*2.54mm

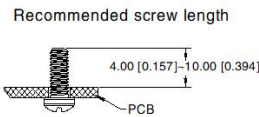

Pin-Out			
Pin	Mark	Pin	Mark
1	+Vin	4	0V
2	Ctrl	5	Sense-
3	-Vin	6	Vset
		7	Sense+
		8	+Vo

KUB6060QB-30ACG Dimensions and Recommended Layout

THIRD ANGLE PROJECTION 

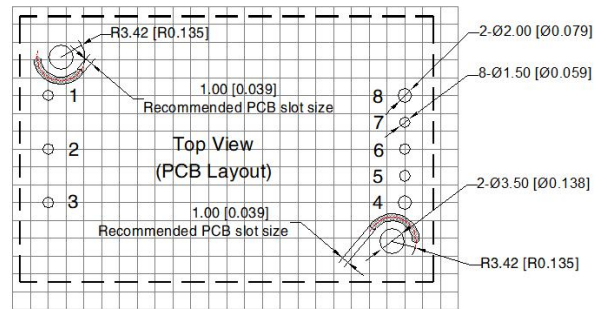
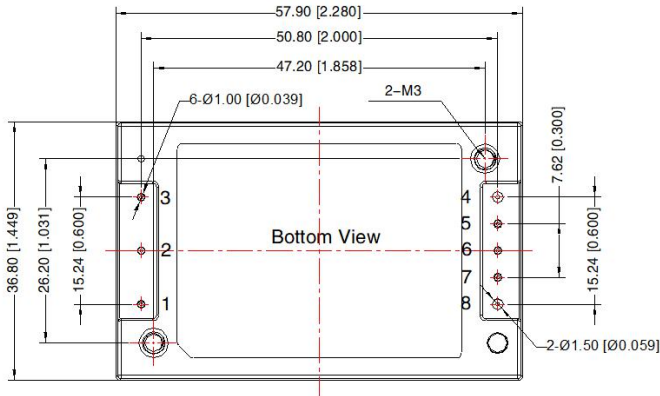
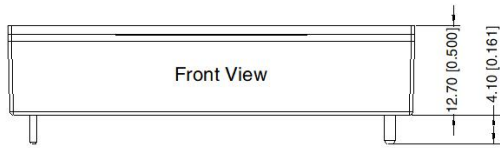

Note: Grid 2.54\*2.54mm

Recommended screw length

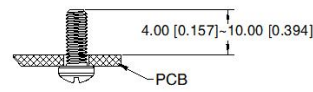

Note:  
Unit: mm[inch]  
Pin1, 2, 3, 5, 6, 7's diameter: 1.00 [0.039]  
Pin4,8's diameter: 1.50 [0.059]  
Pin diameter tolerances:  $\pm 0.10$  [ $\pm 0.004$ ]  
General tolerances:  $\pm 0.50$  [ $\pm 0.020$ ]  
Mounting hole screwing torque:  $0.4 \pm 0.04N \cdot m$

Pin-Out			
Pin	Mark	Pin	Mark
1	+Vin	4	0V
2	Ctrl	5	Iset
3	-Vin	6	Vset
		7	Imon
		8	+Vo

KUB6060QBF-30ACG Dimensions and Recommended Layout

THIRD ANGLE PROJECTION 

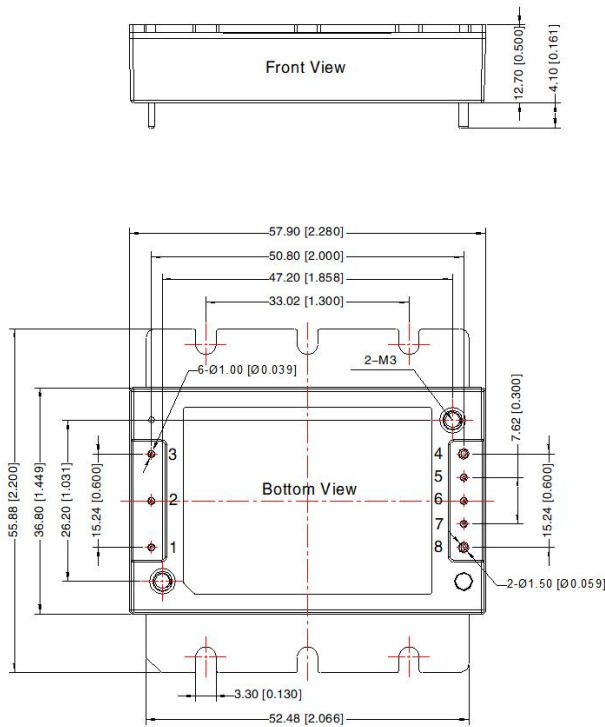

Note:  
Unit: mm[inch]  
Pin1, 2, 3, 5, 6, 7's diameter: 1.00 [0.039]  
Pin4,8's diameter: 1.50 [0.059]  
Pin diameter tolerances:  $\pm 0.10$  [ $\pm 0.004$ ]  
General tolerances:  $\pm 0.50$  [ $\pm 0.020$ ]  
Mounting hole screwing torque:  $0.4 \pm 0.04N \cdot m$

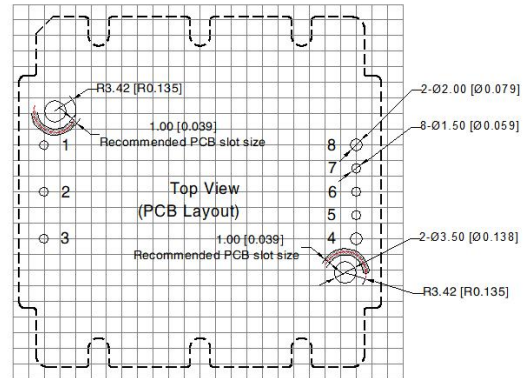

Note: Grid 2.54\*2.54mm

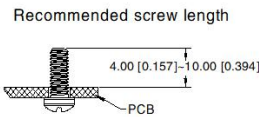

Pin-Out			
Pin	Mark	Pin	Mark
1	+Vin	4	0V
2	Ctrl	5	Iset
3	-Vin	6	Vset
		7	Imon
		8	+Vo

Note:

- For additional information on Product Packaging please refer to [www.mornsun-power.com](http://www.mornsun-power.com). Packaging bag number: 58010113(without "F"), 58020069(with "F");
- The maximum capacitive load offered were tested at nominal input voltage and full load;
- Unless otherwise specified, parameters in this datasheet were measured under the conditions of  $T_a=25^\circ C$ , humidity<75%RH with nominal input voltage and rated output load;
- All index testing methods in this datasheet are based on our company corporate standards;
- We can provide product customization service, please contact our technicians directly for specific information;
- Products are related to laws and regulations: see "Features" and "EMC";
- Our products shall be classified according to ISO14001 and related environmental laws and regulations, and shall be handled by qualified units.

MORNSUN Guangzhou Science & Technology Co., Ltd.

Address: No. 8 Nanyun 4th Road, Huangpu District, Guangzhou, China  
Tel: 86-20-38601850 Fax: 86-20-38601272

E-mail: [info@mornsun.cn](mailto:info@mornsun.cn)

[www.mornsun-power.com](http://www.mornsun-power.com)