

Energy-saving Wide-voltage Contactor Control Module KM115-CL48-O

115A Energy-saving Wide-voltage Contactor Control Module

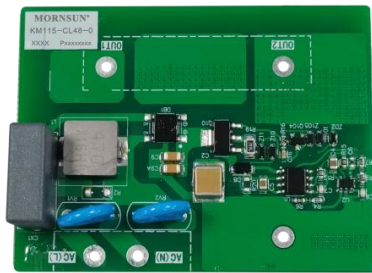

RoHS

FEATURES

- Energy-saving Wide-voltage Contactor Control Module
- Ultra-wide 24 - 60VAC/VDC input voltage range
- Operating ambient temperature range: -40°C to +70°C
- Apparent power lower than 6.5VA
- High reliability
- Maximum operating frequency 3600 times/H
- Quick response, switch delay less than 65ms
- EMS meet CISPR22/EN55022 CLASS A
- 5 years warranty
- Customization available

KM115-CL48-O --- is a control module specially designed for contactor. It only needs one coil and is compatible with many contactor models. It features low power consumption, low delay, small size, low cost, high reliability and strong anti-tripping capability. The product is safe and reliable, with stable pull-in, fast response, wide input voltage range, strong anti-grid power shaking capability, universal AC and DC, no need for short-circuit design. It is widely used in various types of contactor power-saving and a new generation of wide-voltage input contactors. Applicable to the upgrade and optimization needs of most 115A shells in the market.

Selection Guide

Part No.	Contactor Rated operational current	Control voltage range
KM115-CL48-O	115A	24-60 VAC/VDC

Input Specifications

Item	Operating Conditions	Min.	Typ.	Max.	Unit
Input Voltage Range	AC/DC input	24	48	60	VAC/VDC
AC Input Frequency	AC input	47	--	63	Hz
Apparent Power	60VAC	--	--	6.5	VA

Operating Specifications

Item	Operating Conditions	Min.	Typ.	Max.	Unit
Operating Voltage	AC/DC input	--	--	20	VAC/VDC
Releases Voltage	AC/DC input	11	--	14.5	
Operating Current	AC/DC input	5.5	7.3	--	A
Hold-in Current	AC/DC input	0.3	1	--	
Start-up Delay Time	24-60 VDC	--	--	65	ms
	24-60 VAC	--	--	65	
Turn-off Delay Time	24-60 VDC	--	--	40	
	24-60 VAC	--	--	40	
Maximum Operating Frequency	25°C, 60VAC	3600 times / H			
	70°C, 60VAC	2400 times / H			

General Specifications

Item	Operating Conditions	Min.	Typ.	Max.	Unit
Operating Temperature		-40	--	+70	°C
Storage Temperature		-40	--	+85	
Storage Humidity		--	--	95	%RH
Switching Frequency		--	23.5	--	KHz
Safety Class		CLASS II			

Energy-saving Wide-voltage Contactor Control Module KM115-CL48-O

MORNSUN®

MTBF	MIL-HDBK-217F@25°C ≥300,000 h
------	-------------------------------

Mechanical Specifications

Dimension	67.00 x 50.40 x 19.50 mm
Weight	22g(Typ.)
Cooling Method	Free air convection

Electromagnetic Compatibility (EMC)

Emissions	CE	CISPR32/EN55032	CLASS A	
	RE	CISPR32/EN55032	CLASS A	
Immunity	ESD	IEC/EN61000-4-2	Contact ±4KV/ Air ±8KV	perf. Criteria A
	RS	IEC/EN61000-4-3	10V/m	perf. Criteria A
	EFT	IEC/EN61000-4-4	± 2KV	perf. Criteria A
	Surge	IEC/EN61000-4-5	line to line ±1KV	perf. Criteria A
	CS	IEC/EN61000-4-6	10Vr.m.s	perf. Criteria A
	Voltage dips, short interruption and voltage variations	IEC/EN61000-4-11	0%, 70%	perf. Criteria A

Product Characteristic Curve

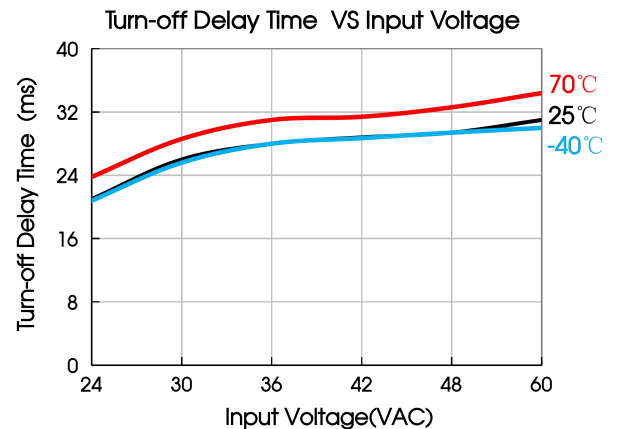
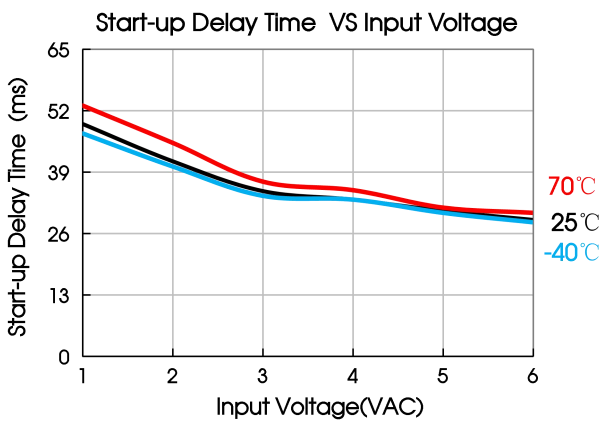
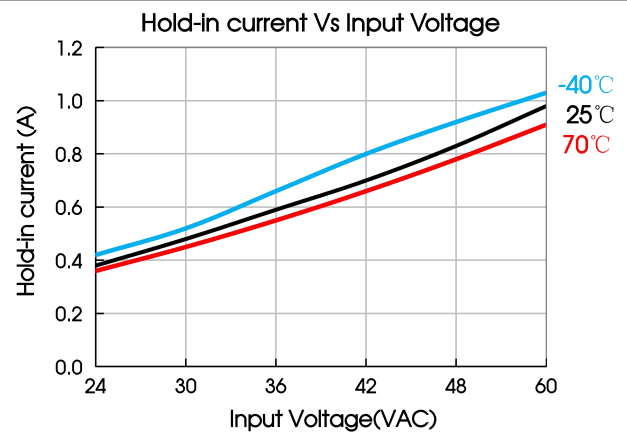
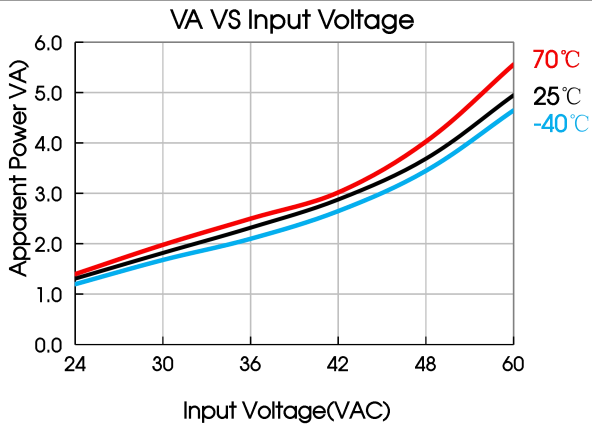

Note: ① This product is suitable for applications using natural air cooling; for applications in closed environment please consult factory or one of our FAE.

Design Reference

1. Typical application

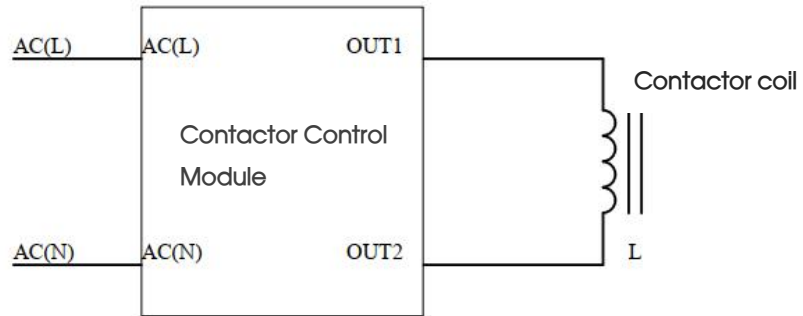

Fig. 1 Typical application

Recommended coil parameter table

Air-cored inductance	Release inductance	Operating inductance	Coil resistance	Coil diameter	Coil turns
2.5mH	8.2mH	16mH	1.8 Ω	0.67mm	330T

Note: The inductance is measured under the condition of 10KHz/0.1V, and the above data are measured at 25 °C.

2. Installation reference

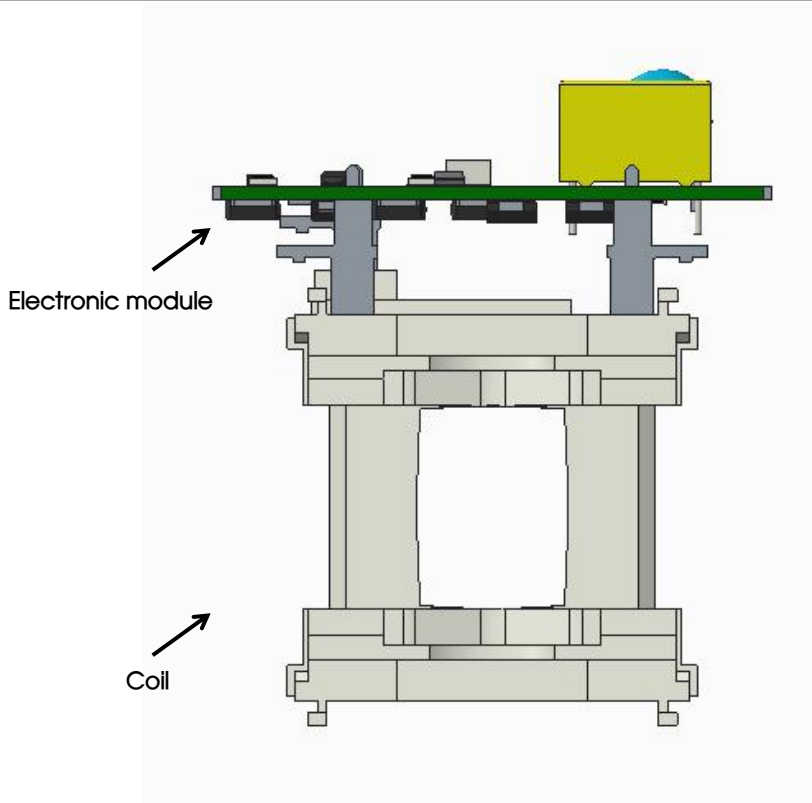

3. For additional information please refer to Contactor Control Module application notes on www.mornsun-power.com.

Dimensions and Recommended Layout

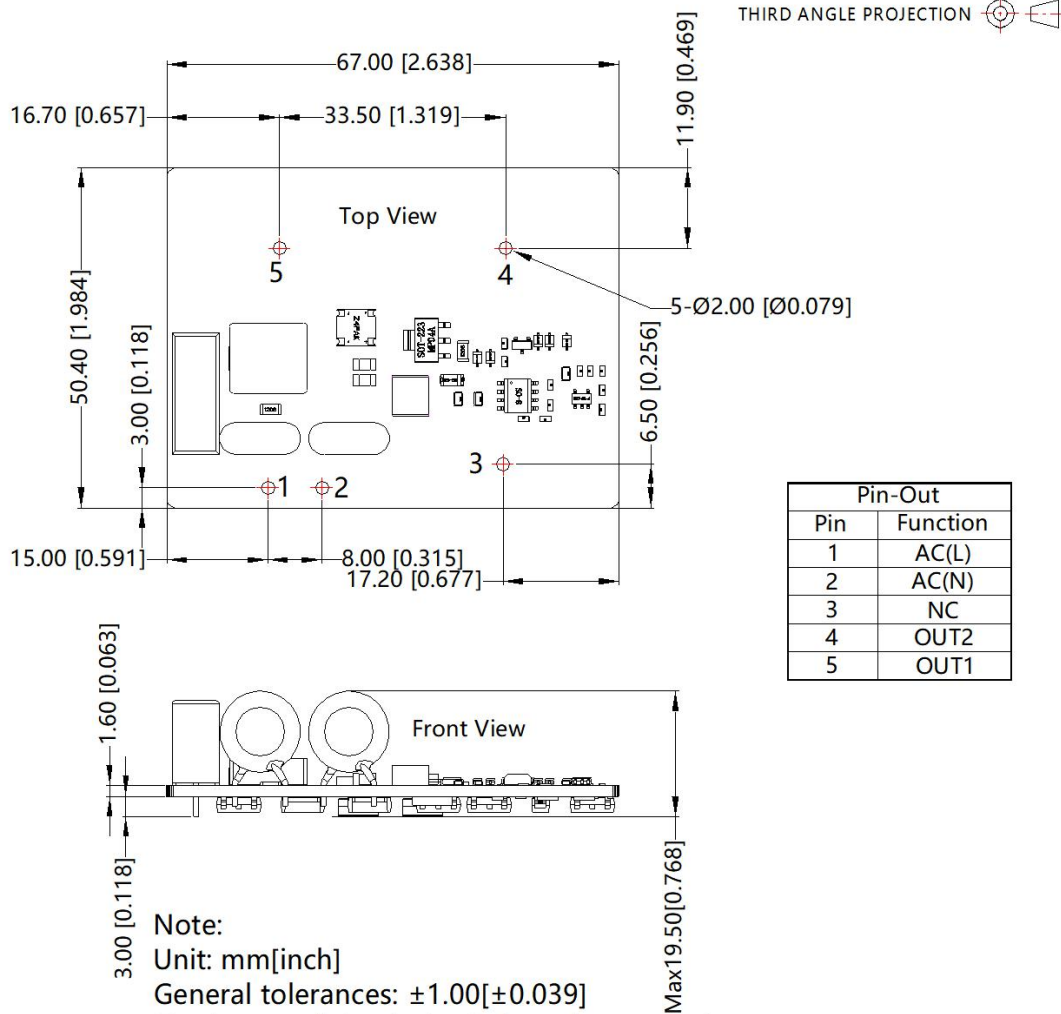

Note:

1. For additional information on Product Packaging please refer to www.mornsun-power.com. Packaging bag number: 58200038;
2. Unless otherwise specified, parameters in this datasheet were measured under the conditions of $T_a=25^\circ\text{C}$, humidity<75% with nominal input voltage;
3. All index testing methods in this datasheet are based on our company corporate standards;
4. We can provide product customization service, please contact our technicians directly for specific information;
5. Products are related to laws and regulations: see "Features" and "EMC";
6. The module should be considered as a part of the contactor, all EMC tests need to be confirmed with the contactor. For guidance on EMC test operation, please consult our FAE;
7. Our products shall be classified according to ISO14001 and related environmental laws and regulations, and shall be handled by qualified units.

Mornsun Guangzhou Science & Technology Co., Ltd.

Address: No. 5, Kehui St. 1, Kehui Development Center, Science Ave., Guangzhou Science City, Huangpu District, Huangpu, P. R. China

Tel: 86-20-38601850

Fax: 86-20-38601272

E-mail: info@mornsun.cn

www.mornsun-power.com