

Non-isolated DC-DC converter
Fixed input voltage and regulated adjustable single output

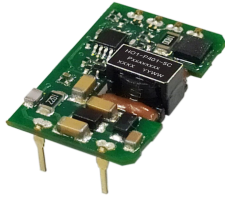

Patent Protection

RoHS



FEATURES

- Continuous output voltage with linear adjustable function
- No-load input current as low as 20mA
- Output voltage with high stability, low time coefficient and temperature coefficient
- Wide operating ambient temperature range: -40°C to +85°C
- Output short-circuit protection, over-current protection
- Meet EN62368 standards

HO1-P401-5C offers output power 2W, it features with wide operating ambient temperature range -40°C to +85°C, output short circuit protection, over-current protection, low time coefficient and temperature coefficient, which are specifically designed for applications in board power systems where high voltages are required and output ripple requirements are high and output voltage stability is critical. They are widely used in fields such as ultrasonic crack detection, ultrasonic thickness measurement, avalanche diodes, solid-state detector, piezoelectric equipment.

Selection Guide

Certification	Part No.	Input Voltage (VDC)	Input Current ^① (mA) Full load/No-load		Output Voltage (VDC)			Current (mA) Max./Min.
		Nominal (Range)	Typ.	Max.	Nominal ^②	Range	Guaranteed range ^③	
--	HO1-P401-5C	12 (10.8-13.2)	250/20	320/30	400	0~+400	+20~+400	5/0

Note:
 ① At the nominal input voltage and nominal output voltage.
 ② When the Vadj control voltage is equal to 5.0VDC (Typ.), the output voltage is 400V. The relationship curve between output voltage and control voltage is shown in Fig.3;
 ③ Within this range, the product meets the adjust-point tolerance.

Input Specifications

Item	Operating Conditions	Min.	Typ.	Max.	Unit
Reflected Ripple Current ^①		--	30	--	mA
Surge Voltage (1sec. max.)		--	--	18	VDC
Input Filter Type		Capacitor filter			
Hot Plug		Unavailable			

Note:
 ① Refer to DC-DC Converter Application Notes for detailed description of reflected ripple current test method.

Output Specifications

Item	Operating Conditions	Min.	Typ.	Max.	Unit
Adjust-point Tolerance	Output voltage guaranteed range, see fig.3	-2	±1	+3	%
Linear Regulation	Input voltage range, nominal output voltage, full load	--	±0.01	±0.03	
Load Regulation	Nominal input voltage, nominal output voltage, 10%-100% load	--	±0.3	±0.5	
Time Coefficient	Nominal input voltage, nominal output voltage, full load, after warming up for 30 minutes	--	±0.001	±0.003	%/Hr
Temperature Coefficient	Nominal input voltage, nominal output voltage, full load	--	±100	--	PPM/°C
Ripple & Noise ^①	20MHz bandwidth, nominal input voltage, 0%-100% load, see Fig.4	--	40	--	mVp-p
Over-current Protection / Short-circuit Protection	Input voltage range	Constant current mode, continuous, self-recovery			

Note:
 ① Please refer to fig.4 for the test method of ripple and noise, the product is working by the linear power source;

General Specifications

Item	Operating Conditions	Min.	Typ.	Max.	Unit
Operating Temperature	See Fig. 1	-40	--	+85	°C
Storage Temperature		-55	--	+105	
Storage Humidity	Non-condensing	5	--	85	%RH
Pin Soldering Resistance Temperature	Soldering spot is 1.5mm away from case for 10 seconds	--	--	300	°C
Vibration		10-150Hz, 5G, 0.75mm. along X, Y and Z			
Switching Frequency	Nominal input voltage, full load	--	200	--	kHz
MTBF	MIL-HDBK-217F@25°C	1000	--	--	k hours

Mechanical Specifications

Case Material	OPen board
Dimensions	24.00 x 15.10 x 5.88 mm
Weight	1.8g (Typ.)
Cooling Method	Free air convection

Electromagnetic Compatibility (EMC)

Emissions	CE	CISPR32/EN55032 CLASS B (see Fig.5 for recommended circuit)
	RE	CISPR32/EN55032 CLASS B (Without extra components)

Product Characteristic Curve

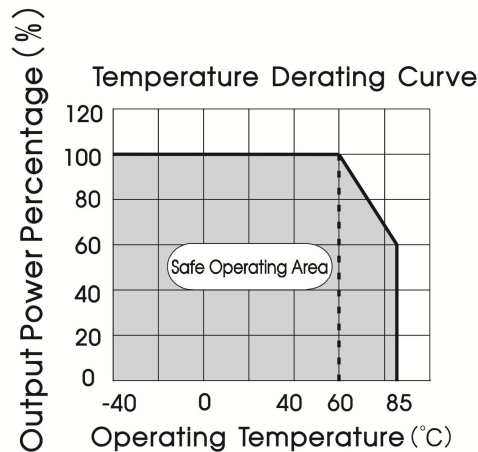
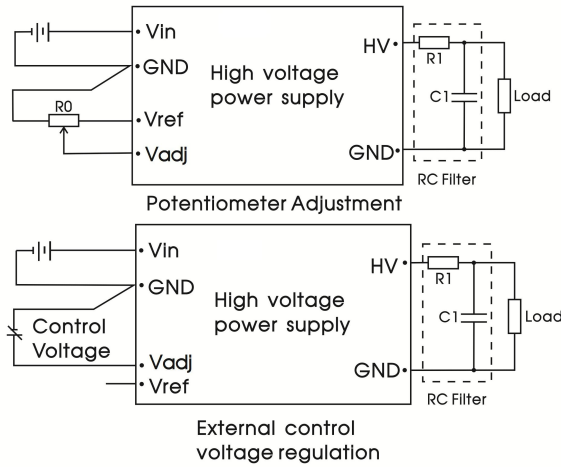

Fig. 1

Design Reference

1. Typical application

The output voltage of the product can be adjusted by an external circuit. There are two adjustment methods, as shown in Fig.2. The relationship curve between output voltage of the product and control voltage is shown in Fig.3.



Parameter description:

R0	10KΩ Adjustable resistance
R1	0~300Ω Resistance
C1	100nF/630V Capacitor
Vref	5.15VC
Control Voltage	0-5.0VDC

Fig. 2 External adjustment method of output voltage

Output Voltage-Control Voltage relationship Curve

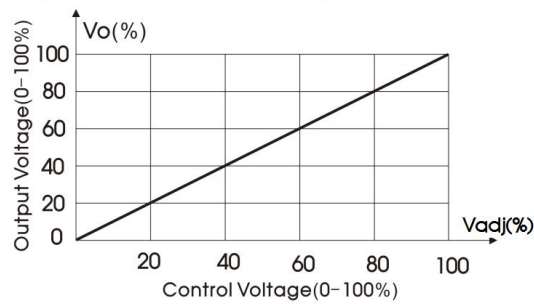

(Note: 100% Vadj is equal to 5.0VDC (Typ.))

Fig. 3 The relationship curve of output voltage and control voltage

2. Ripple & Noise testing compliance circuit

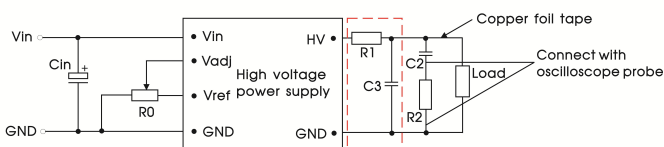

Fig.4 Ripple and noise test recommended circuit

Parameter description:

Cin	100μF/50V Aluminum electrolytic capacitor
R0	10KΩ Adjustable resistance
R1	0~300Ω Resistance
C3	100nF/630V Capacitor
C2	472K/250VAC Y2 Capacitor
R2	1KΩ/2W Resistance

3. EMC compliance circuit

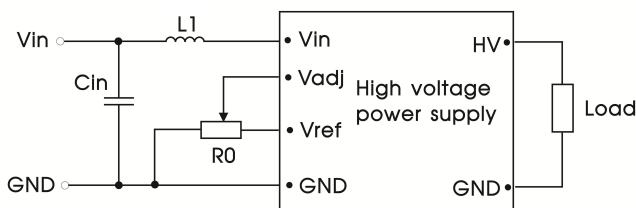

Fig. 5 EMC compliance circuit

Parameter description:

Cin	22μF/25V Capacitor
R0	10kΩ Adjustable resistance
L1	82μH Inductance

4. For additional information please refer to DC-DC converter application notes on www.mornsun.cn

Dimensions and Recommended Layout

THIRD ANGLE PROJECTION 

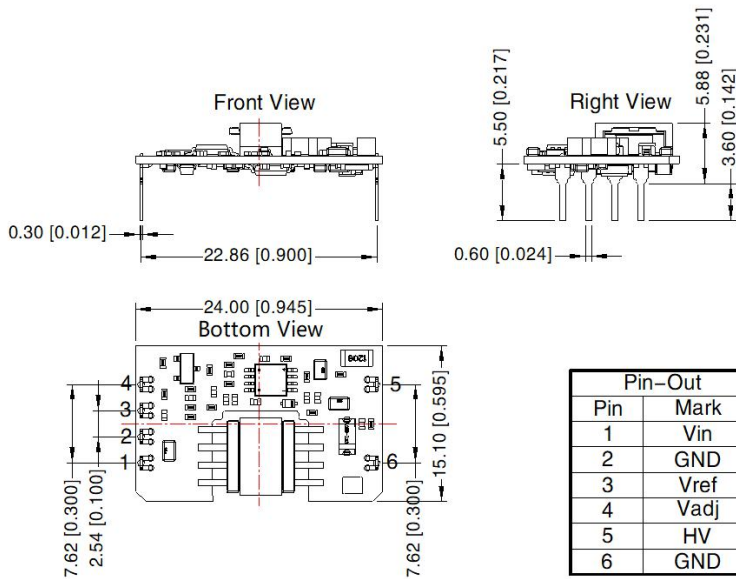

Pin-Out	
Pin	Mark
1	Vin
2	GND
3	Vref
4	Vadj
5	HV
6	GND

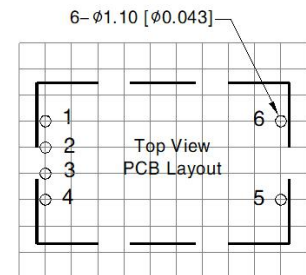

Note: Grid 2.54*2.54mm

Note:
Unit: mm[inch]
Pin diameter tolerances: $\pm 0.10[\pm 0.004]$
General tolerances: $\pm 0.50[\pm 0.020]$
The layout of the device is for reference only,
please refer to the actual product

Notes:

1. For additional information please refer to Product Packaging Information. Packaging bag number: 58210106;
2. If the product is not operated within the required load range, the product performance cannot be guaranteed to comply with all parameters in the datasheet;
3. Unless otherwise specified, parameters in this datasheet were measured under the conditions of $T_a=25^\circ\text{C}$, humidity<75%RH with nominal input voltage and rated output load;
4. All index testing methods in this datasheet are based on our company corporate standards;
5. We can provide product customization service;
6. Products are related to laws and regulations: see "Features" and "EMC";
7. Our products shall be classified according to ISO14001 and related environmental laws and regulations, and shall be handled by qualified units.

Mornsun Guangzhou Science & Technology Co., Ltd.

Address: No. 5, Kehui St. 1, Kehui Development Center, Science Ave., Guangzhou Science City, Huangpu District, Guangzhou, P. R. China
Tel: 86-20-38601850 Fax: 86-20-38601272 E-mail: info@mornsun.cn www.mornsun-power.com