

2W isolated DC-DC converter  
Fixed input voltage, unregulated dual or single output

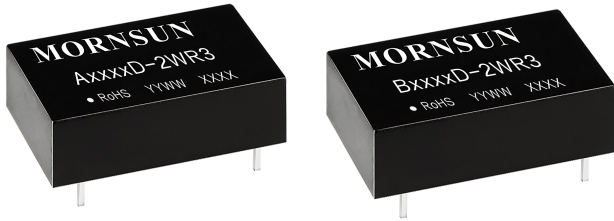

Patent Protection RoHS

### FEATURES

- Continuous short-circuit protection
- No-load input current as low as 8mA
- Operating ambient temperature range: -40°C to +105°C
- High efficiency up to 88%
- High power density
- I/O isolation test voltage: 1.5kVDC
- Industry standard pin-out

A\_D-2WR3 & B\_D-2WR3 series are specially designed for applications where an (two) isolated voltage is required in a distributed power supply system. They are suitable for: pure digital circuits, low frequency analog circuits, relay-driven circuits and data switching circuits.

### Selection Guide

Certification	Part No.	Input Voltage (VDC)	Output		Full Load Efficiency (%) Min./Typ.	Capacitive Load*( $\mu$ F) Max.
		Nominal (Range)	Voltage (VDC)	Current (mA) Max./Min.		
-	B0303D-2WR3	3.3 (2.97-3.63)	3.3	400/40	74/78	2400
	B0305D-2WR3		5	400/40	74/78	2400
	A0503D-2WR3	5 (4.5-5.5)	$\pm$ 3.3	$\pm$ 303/ $\pm$ 30	74/78	1200
	A0505D-2WR3		$\pm$ 5	$\pm$ 200/ $\pm$ 20	80/84	1200
	A05X7D-2WR3		$\pm$ 7	$\pm$ 143/ $\pm$ 14	80/84	470
	A0509D-2WR3		$\pm$ 9	$\pm$ 111/ $\pm$ 11	81/85	470
	A0512D-2WR3		$\pm$ 12	$\pm$ 83/ $\pm$ 8	81/85	220
	A0515D-2WR3		$\pm$ 15	$\pm$ 67/ $\pm$ 7	82/86	220
	A0524D-2WR3		$\pm$ 24	$\pm$ 42/ $\pm$ 4	82/86	100
	B0503D-2WR3		3.3	400/40	74/78	2400
	B0505D-2WR3		5	400/40	80/84	2400
	B0509D-2WR3		9	222/22	81/85	1000
	B0512D-2WR3	12	167/17	81/85	560	
	B0515D-2WR3	15	133/13	82/86	560	
	B0524D-2WR3	24	83/8	82/86	220	
	A1205D-2WR3	12 (10.8-13.2)	$\pm$ 5	$\pm$ 200/ $\pm$ 20	76/80	1200
	A1209D-2WR3		$\pm$ 9	$\pm$ 111/ $\pm$ 11	78/82	500
	A1212D-2WR3		$\pm$ 12	$\pm$ 83/ $\pm$ 8	79/83	280
	A1215D-2WR3		$\pm$ 15	$\pm$ 67/ $\pm$ 7	79/83	280
	A1224D-2WR3		$\pm$ 24	$\pm$ 42/ $\pm$ 4	81/85	110
	B1205D-2WR3		5	400/40	78/82	2400
	B1209D-2WR3		9	222/23	78/82	1000
	B1212D-2WR3		12	167/17	80/84	560
	B1215D-2WR3		15	133/13	81/85	560
	B1224D-2WR3		24	83/8	82/86	220
	A1515D-2WR3	15 (13.5-16.5)	$\pm$ 15	$\pm$ 67/ $\pm$ 7	77/81	280
	B1505D-2WR3		5	400/40	75/79	2400
	B1509D-2WR3		9	222/23	78/82	1000
	B1515D-2WR3		15	133/13	75/79	560
	A2405D-2WR3	24 (21.6-26.4)	$\pm$ 5	$\pm$ 200/ $\pm$ 20	74/80	1200
A2409D-2WR3	$\pm$ 9		$\pm$ 111/ $\pm$ 11	75/81	500	
A2412D-2WR3	$\pm$ 12		$\pm$ 83/ $\pm$ 8	77/83	280	

--	A2415D-2WR3	24 (21.6-26.4)	±15	±67/±7	77/83	280
	A2424D-2WR3		±24	±42/±4	77/83	110
	B2405D-2WR3		5	400/40	76/82	2400
	B2409D-2WR3		9	222/23	76/82	1000
	B2412D-2WR3		12	167/17	80/86	560
	B2415D-2WR3		15	133/13	82/88	560
	B2424D-2WR3		24	83/8	82/88	220

Note: \* The specified maximum capacitive load for positive and negative output is identical.

### Input Specifications

Item	Operating Conditions		Min.	Typ.	Max.	Unit
Input Current (full load / no-load)	3.3VDC input	3.3VDC output	--	513/12	541/--	mA
		5VDC output	--	778/12	820/--	
	5VDC input	3.3VDC output	--	513/8	541/--	
		5VDC/7VDC output	--	477/8	500/--	
		9VDC/12VDC output	--	471/8	494/--	
		15VDC/24VDC output	--	466/8	488/--	
	A12_D-2WR3	5VDC output	--	209/8	220/--	
		9VDC output	--	204/8	214/--	
		12VDC/15VDC output	--	201/8	211/--	
	B12_D-2WR3	24VDC output	--	197/8	206/--	
		5VDC/9VDC output	--	204/8	214/--	
		12VDC output	--	199/8	209/--	
	A15_D-2WR3	15VDC output	--	196/8	206/--	
		24VDC output	--	194/8	204/--	
		15VDC output	--	165/8	173/--	
	B15_D-2WR3	5VDC/15VDC output	--	169/8	178/--	
		9VDC output	--	163/8	171/--	
	A24_D-2WR3	5VDC output	--	105/8	113/--	
		9VDC 输出	--	103/8	112/--	
		12VDC/15VDC/24VDC output	--	101/8	109/--	
B24_D-2WR3	5VDC/9VDC output	--	102/8	110/--		
	12VDC output	--	97/8	105/--		
	15VDC/24VDC output	--	95/8	102/--		
Reflected Ripple Current	3.3V input		--	30	--	
	Others		--	15	--	
Surge Voltage (1sec. max.)	3.3VDC input		-0.7	--	5	
	5VDC input		-0.7	--	9	
	12V input		-0.7	--	18	
	15V input		-0.7	--	21	
	24V input		-0.7	--	30	
Input Filter			Capacitance filter			
Hot Plug			Unavailable			

Output Specifications

Item	Operating Conditions		Min.	Typ.	Max.	Unit	
Voltage Accuracy			See output regulation curve (Fig. 1)				
Linear Regulation	Input voltage change: ±1%		3.3VDC output	--	--	±1.5	--
			Other output	--	--	±1.2	
Load Regulation	10%-100% load	3.3VDC input	3.3VDC output	--	15	20	%
			5VDC output	--	20	25	
		5VDC input	3.3VDC output	--	12	20	
			5VDC/7VDC output	--	9	15	
			9VDC/12VDC/15VDC output	--	7	10	
			24VDC output	--	5	10	
		Other input	5VDC output	--	7	15	
			9VDC output	--	5	10	
			12VDC output	--	5	10	
			15VDC output	--	4	10	
		24VDC output	--	3	10		
Ripple & Noise*	20MHz bandwidth	3.3V/5VDC input		--	75	200	mVp-p
		Other input	5/9/12/15VDC output	--	75	180	
			24VDC output	--	75	200	
Temperature Coefficient	Full load		--	±0.02	--	%/°C	
Short-circuit Protection			Continuous, self-recovery				

Notes: \* The "parallel cable" method is used for ripple and noise test, please refer to DC-DC Converter Application Notes for specific information.

General Specifications

Item	Operating Conditions		Min.	Typ.	Max.	Unit
Isolation	Input-output electric strength test for 1 minute with a leakage current of 1mA max.		1500	--	--	VDC
Insulation Resistance	Input-output resistance at 500VDC		1000	--	--	MΩ
Isolation Capacitance	Input-output capacitance at 100kHz/0.1V		--	20	--	pF
Operating Temperature	Derating when operating temperature ≥85°C ( see Fig. 2)		-40	--	105	°C
Storage Temperature			-55	--	125	
Case Temperature Rise	Tα=25°C		--	25	--	
Pin Soldering Resistance Temperature	Soldering spot is 1.5mm away from case for 10 seconds		--	--	300	
Storage Humidity	Non-condensing		5	--	95	%RH
Vibration			10-150Hz, 5G, 0.75mm. along X, Y and Z			
Switching Frequency	100% load, nominal input voltage	3.3/5VDC input	--	220	--	kHz
		Other input	--	260	--	
MTBF	MIL-HDBK-217F@25°C		3500	--	--	k hours

Mechanical Specifications

Case Material	Black plastic; flame-retardant and heat-resistant (UL94 V-0)
Dimensions	20.32 x 10.16 x 8.20 mm
Weight	2.4g(Typ.)
Cooling Method	Free air convection

Electromagnetic Compatibility (EMC)

Emission	CE	CISPR32/EN55032	CLASS B
	RE	CISPR32/EN55032	CLASS B
Immunity	ESD	IEC/EN61000-4-2	Air ±8kV, Contact ±6kV perf. Criteria B

Note: Refer to Fig. 4 for recommended circuit test.

Typical Characteristic Curves

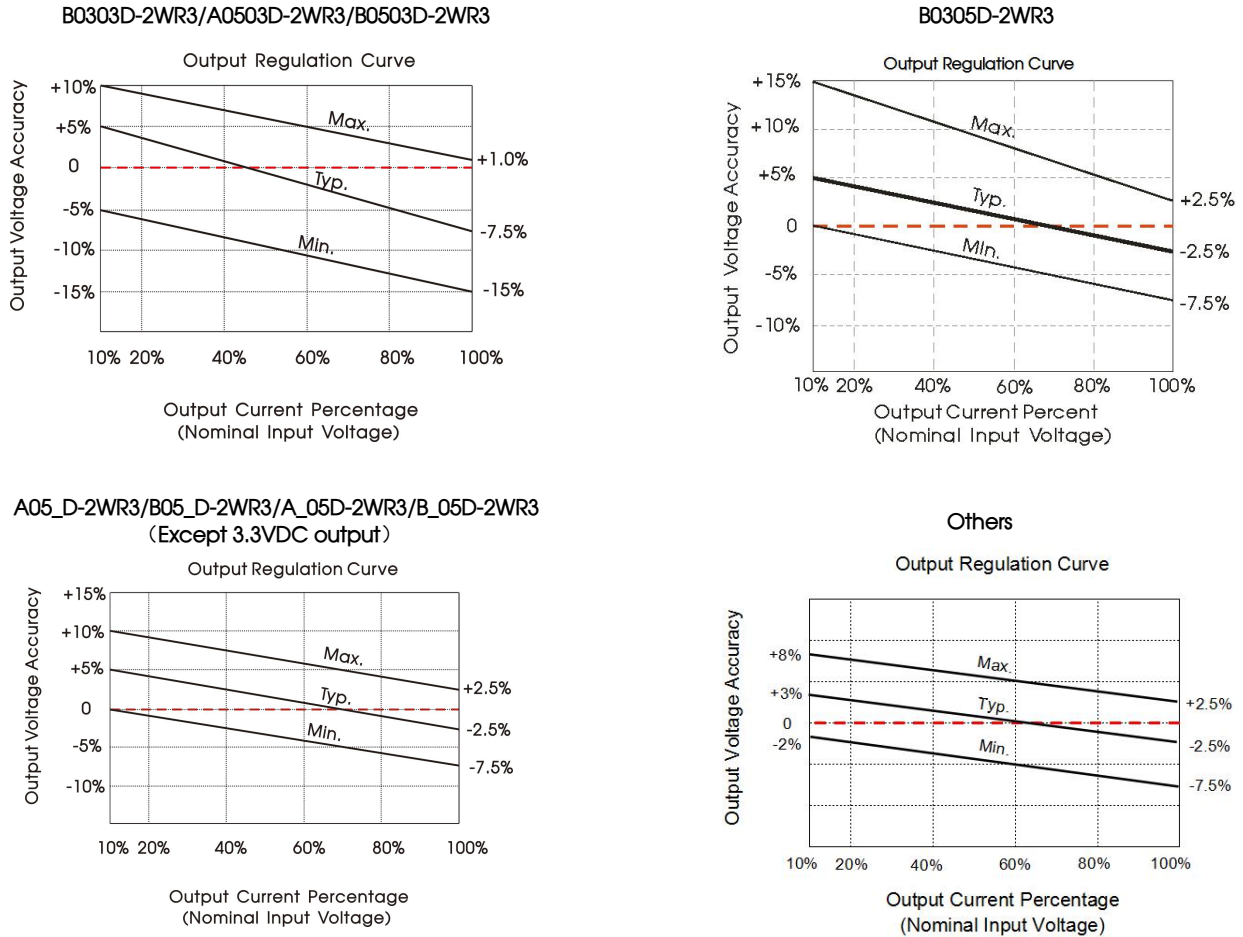

Fig. 1

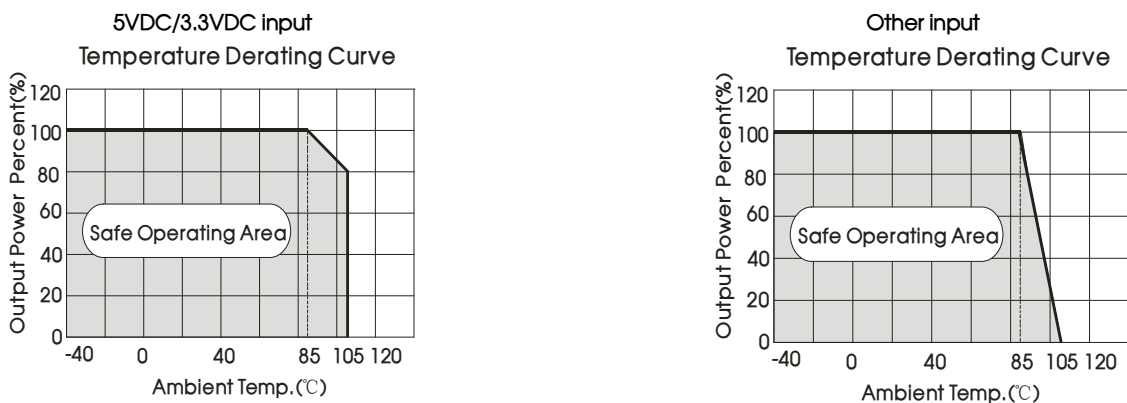
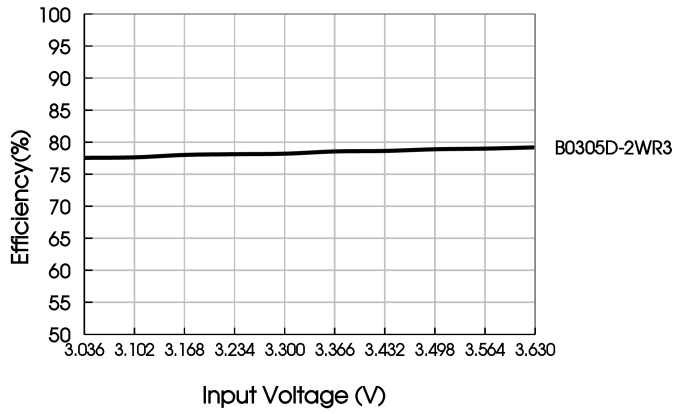
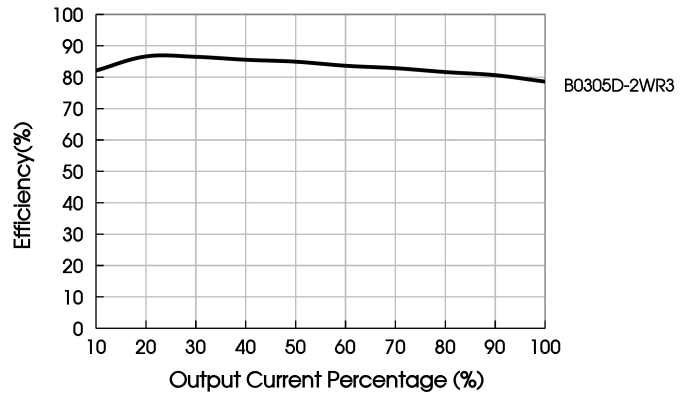

Fig. 2

Efficiency Vs Input Voltage (Full Load)



Efficiency Vs Output Load (Vin=3.3V)



Efficiency Vs Input Voltage (Full Load)

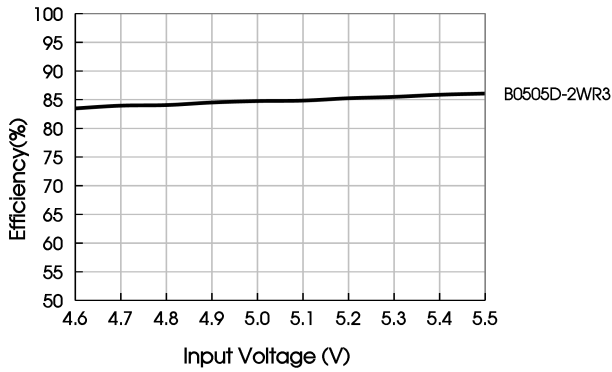

Efficiency Vs Output Load (Vin=5V)

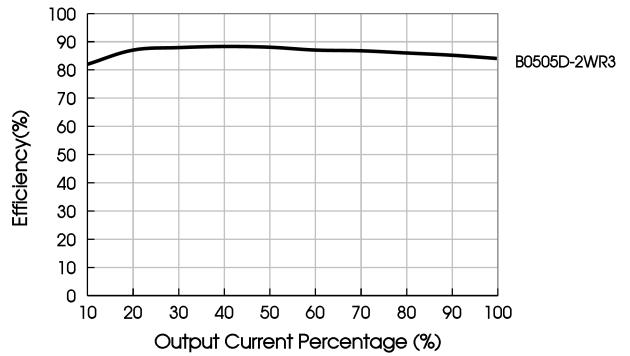

Efficiency Vs Input Voltage (Full Load)

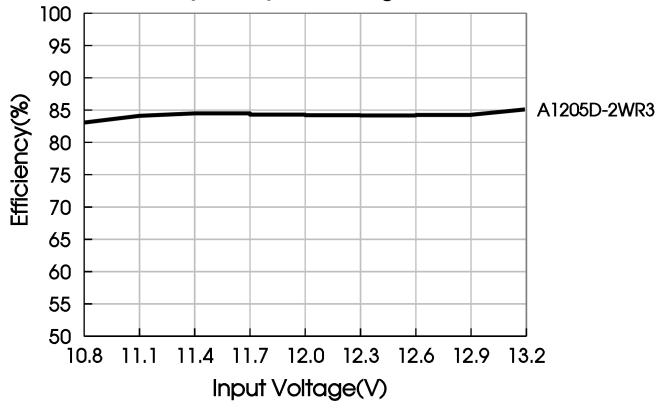

Efficiency Vs Output Load (Vin=12V)

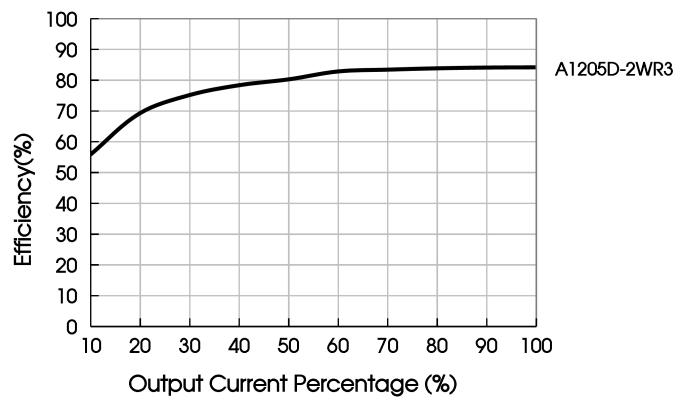

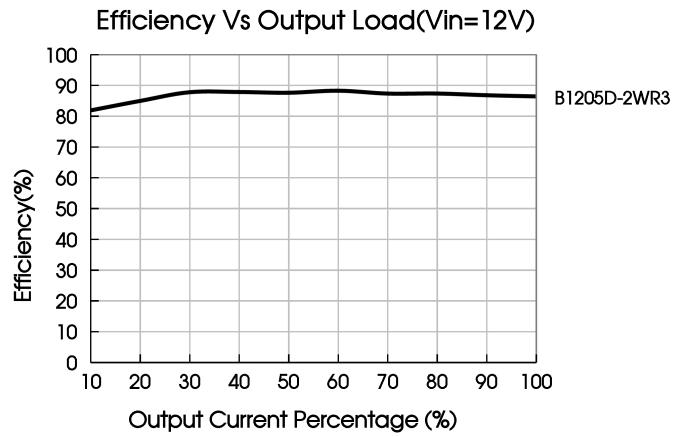
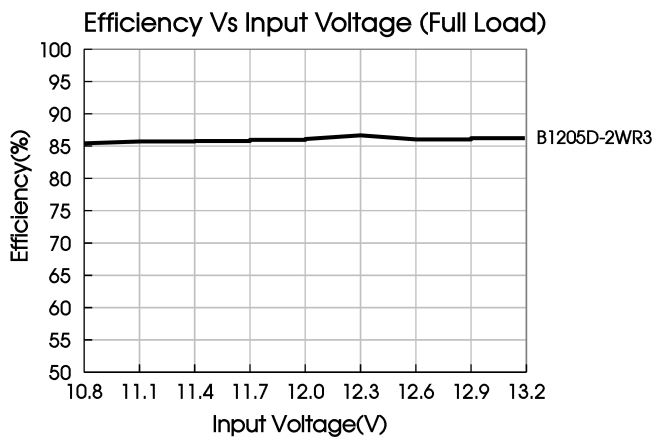

## Design Reference

### 1. Typical application

Input and/or output ripple can be further reduced, by connecting a filter capacitor from the input and/or output terminals to ground as shown in Fig.3.

Choosing suitable filter capacitor values is very important for a smooth operation of the modules, particularly to avoid start-up problems caused by capacitor values that are too high. For recommended input and output capacitor values refer to Table 1.

Dual



Single



Fig.3

Table 1: Recommended input and output capacitor values

Vin	Cin	Dual Vout	Cout*	Single Vout	Cout
3.3VDC	10μF/16V	±3.3VDC	4.7μF/16V	3.3VDC	10μF/16V
5VDC	4.7μF/16V	±5/±7VDC	4.7μF/16V	5VDC	10μF/16V
12VDC	2.2μF/25V	±9VDC	1μF/16V	9VDC	2.2μF/25V
15VDC	2.2μF/25V	±12/±15VDC	1μF/25V	12VDC	2.2μF/25V
24VDC	1μF/50V	±24VDC	0.47μF/50V	15VDC	2.2μF/25V
--	--	--	--	24VDC	1μF/50V

Note: \*The capacitor value of the positive and the negative output is identical.

### 2. EMC compliance circuit

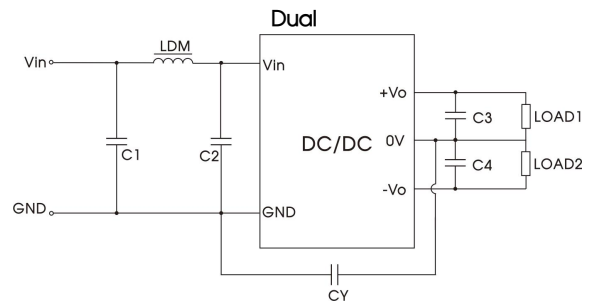
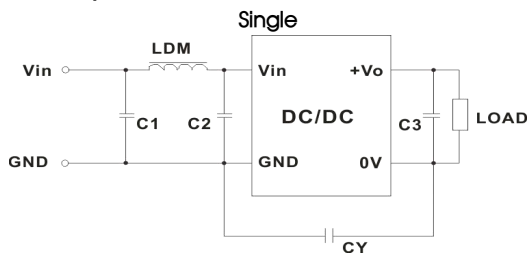

Fig.4

Emissions	C1/C2	4.7μF/50V
	CY	270pF/2kV
	C3/C4	Refer to the Cout in Fig.3
	LDM	6.8μH

3. For additional information, please refer to DC-DC converter application notes on

[www.mornsun-power.com](http://www.mornsun-power.com)



Dimensions and Recommended Layout

THIRD ANGLE PROJECTION

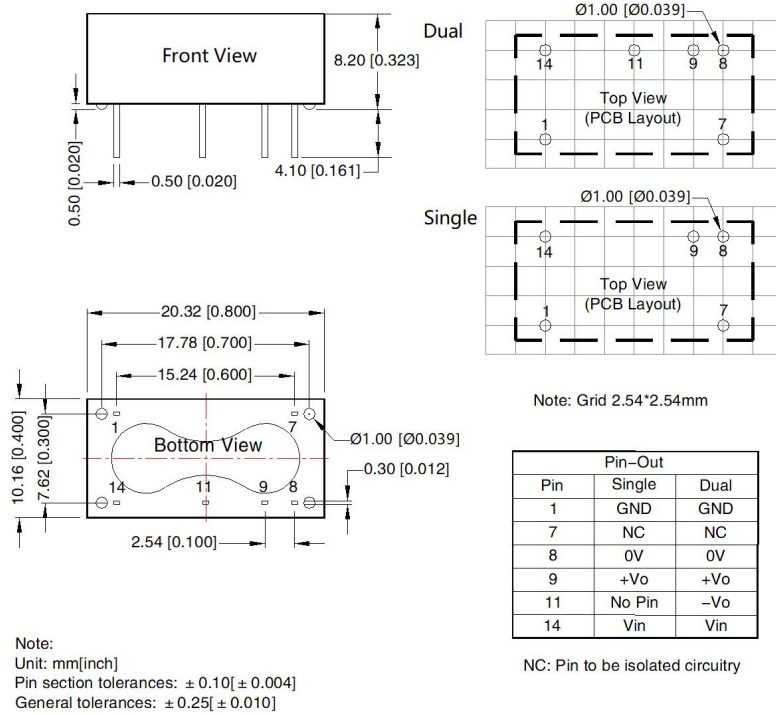

Notes:

1. For additional information on Product Packaging please refer to [www.mornsun-power.com](http://www.mornsun-power.com). Packaging bag number: 58200009;
2. If the product is not operated within the required load range, the product performance cannot be guaranteed to comply with all parameters in the datasheet;
3. The maximum capacitive load offered were tested at input voltage range and full load;
4. Unless otherwise specified, parameters in this datasheet were measured under the conditions of Ta=25°C, humidity<75%RH with nominal input voltage and rated output load;
5. All index testing methods in this datasheet are based on our company corporate standards;
6. We can provide product customization service, please contact our technicians directly for specific information;
7. Products are related to laws and regulations: see "Features" and "EMC";
8. Our products shall be classified according to ISO14001 and related environmental laws and regulations, and shall be handled by qualified units.

MORNSUN Guangzhou Science & Technology Co., Ltd.

Address: No. 5, Kehui St. 1, Kehui Development Center, Science Ave., Guangzhou Science City, Huangpu District, Guangzhou, P. R. China  
Tel: 86-20-38601850 Fax: 86-20-38601272 E-mail: [info@mornsun.cn](mailto:info@mornsun.cn) [www.mornsun-power.com](http://www.mornsun-power.com)