

## A\_M-1W & B\_LM-1W Series

### 1W, FIXED INPUT, ISOLATED & UNREGULATED

### DUAL/SINGLE OUTPUT, SUPERMINIATURE SIP PACKAGE

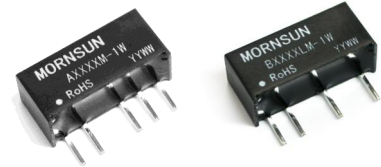

RoHS

#### FEATURES

- Efficiency up to 80%
- Miniature SIP Package Style
- Temperature Range: -40°C to +85°C
- Internal SMD Construction
- Industry Standard Pinout
- No Heat sink Required
- No External Component Required
- RoHS Compliance

#### APPLICATIONS

The A\_M-1W & B\_LM-1W Series are specially designed for applications where a group of polar power supplies are isolated from the input power supply in a distributed power supply system on a circuit board.

These products apply to:

- Where the voltage of the input power supply is fixed (voltage variation  $\leq \pm 10\%$ );
- Where isolation is necessary between input and output (isolation voltage  $\leq 1000\text{VDC}$ );
- Where the regulation of the output voltage and the output ripple noise are not demanding.

Such as: purely digital circuits, ordinary low frequency analog circuits, and IGBT power device driving circuits.

#### MODEL SELECTION

B0505LM-1W

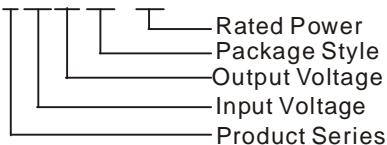

#### MORNSUN Science & Technology Co., Ltd.

Address: No. 5, Kehui St. 1, Kehui development center, Science Ave., Guangzhou Science City, Luogang district, Guangzhou, P.R.China.

Tel: 86-20-28203030

Fax: 86-20-28203068

[Http://www.mornsun-power.com](http://www.mornsun-power.com)

#### PRODUCT PROGRAM

Part Number	Input		Output			Efficiency (% Typ)
	Voltage (VDC)		Voltage (VDC)	Current (mA)		
	Nominal	Range		Max	Min	
A0505M-1W	5	4.5-5.5	±5	±100	±10	70
A0509M-1W			±9	±56	±6	75
A0512M-1W			±12	±42	±5	78
A0515M-1W			±15	±33	±4	79
B0505LM-1W			5	200	20	70
B0509LM-1W	9	111	12	75		
B0512LM-1W	12	83	9	79		
B0515LM-1W	15	67	7	80		
B0524LM-1W	24	42	5	84		
A1205M-1W	12	10.8-13.2	±5	±100	±10	72
*A1209M-1W			±9	±56	±6	75
A1212M-1W			±12	±42	±5	77
B1205LM-1W			5	200	20	72
B1209LM-1W			9	111	12	75
B1212LM-1W	12	83	9	77		
B1215LM-1W	15	67	7	79		
B1224LM-1W	24	42	5	84		
A2405M-1W	24	21.6-26.4	±5	±100	±10	70
A2412M-1W			±12	±42	±5	79
A2415M-1W			±15	±33	±4	81
B2405LM-1W			5	200	20	70
B2409LM-1W			9	111	12	73
B2412LM-1W	12	83	9	75		
B2415LM-1W	15	67	7	78		
B2424LM-1W	24	42	5	77		

#### OUTPUT SPECIFICATION

Item	Test Conditions	Min	Typ	Max	Units
Output power		0.1		1	W
Line regulation	For $V_{in}$ change of 1%			1.2	%
Load regulation	10% to 100% full load(5V output)		10	15	
	10% to 100% full load(9V output)		8.3	10	
	10% to 100% full load(12V output)		6.8	10	
	10% to 100% full load(15V output)		6.3	10	
	10% to 100% full load(24V output)		5	10	
Temperature drift	100% full load			0.03	%/°C
Output voltage accuracy		See tolerance envelope graph			
Ripple & Noise*	20MHz Bandwidth(AXXXXM-1W)		50	75	mVp-p
	20MHz Bandwidth(BXXXXLM-1W)		75	100	
Switching frequency	100% load, nominal input(5V,12V)		100		KHz
	100% load, nominal input(24V)		500		

\*Test ripple and noise by "parallel cable" method. See detailed operation instructions at Testing of Power Converter section, application notes.

## ISOLATION SPECIFICATIONS

Item	Test conditions	Min	Typ	Max	Units
Isolation voltage	Tested for 1 minute and 1mA max	1000			VDC
Isolation resistance	Test at 500VDC	1000			MΩ

## COMMON SPECIFICATION

Item	Test Conditions	Min	Typ	Max	Units
Storage humidity				95	%
Operating temperature		-40		85	°C
Storage temperature		-55		125	
Temp. rise at full load			15	25	
Lead temperature	1.5mm from case for 10 seconds			300	
Cooling		Free air convection			
Case material		Plastic(UL94-V0)			
Short circuit protection*				1	S
MTBF		3500			K hours
Weight			2.1		g

\*Supply voltage must be discontinued at the end of short circuit duration.

Note:

1. Operation under minimum load will not damage the converter; However, they may not meet all specification listed, and that will reduce the life of product.
2. All specifications measured at TA=25°C, humidity<75%, nominal input voltage and rated output load unless otherwise specified.
3. See below recommended circuits for more details.

## TYPICAL CHARACTERISTICS

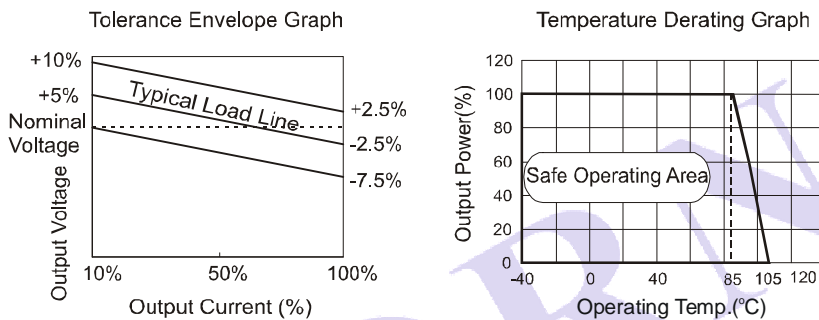

## OUTLINE DIMENSIONS & PIN CONNECTIONS

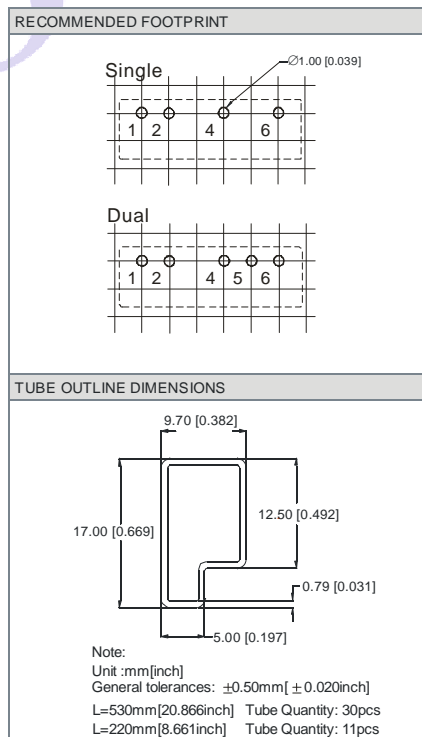
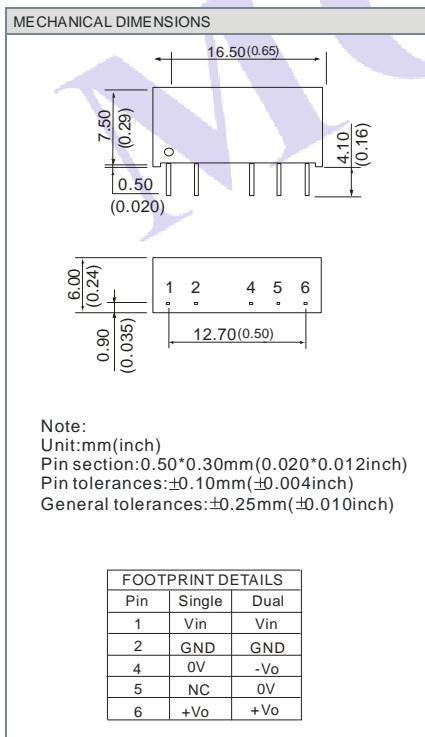

## APPLICATION NOTE

### Requirement On Output Load

To ensure this module can operate efficiently and reliably, a minimum load is specified for this kind of DC/DC converter in addition to a maximum load (namely full load). During operation, make sure the specified range of input voltage is not exceeded the minimum output load could not be less than 10% of the full load. If the actual output power is very small, please connect a resistor with proper resistance at the output end in parallel to increase the load, or use our company's products with a lower rated output power (A\_M-W2 & B\_LM-W2 Series).

### Overload Protection

Under normal operating conditions, the output circuit of these products has no protection against overload. The simplest method is to connect a self-recovery fuse in series at the input end or add a circuit breaker to the circuit.

### Recommended testing and application circuit

If you want to further decrease the input/output ripple, an "LC" filtering network may be connected to the input and output ends of the DC/DC converter, see (Figure 1).

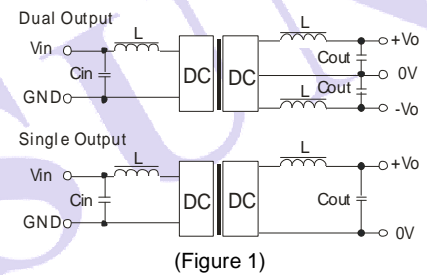

It should also be noted that the inductance and the frequency of the "LC" filtering network should be staggered with the DC/DC frequency to avoid mutual interference. However, the capacitance of the output filter capacitor must be proper. If the capacitance is too big, a startup problem might arise. For every channel of output, provided the safe and reliable operation is ensured, the recommended capacitance of its filter capacitor sees (Table 1).

EXTERNAL CAPACITOR TABLE (Table 1)

Vin (VDC)	Cin (uF)	Single Vout (VDC)	Cout (uF)	Dual Vout (VDC)	Cout (uF)
5	4.7	5	10	±5	4.7
12	2.2	9	4.7	±9	2.2
24	1	12	2.2	±12	1
-	-	15/24	1	±15	0.47

It's not recommended to connect any external capacitor in the application field with less than 0.5 watt output.

### Output Voltage Regulation and Over-voltage Protection Circuit

The simplest device for output voltage regulation, over-voltage and over-current protection is a linear voltage regulator with overheat protection that is connected to the input or output end in series (Figure 2).

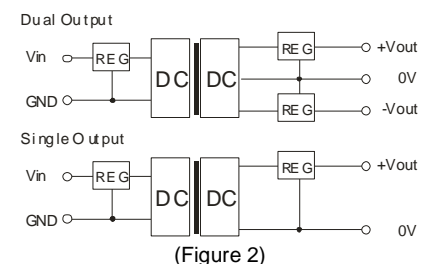

**No parallel connection or plug and play.**