

QA01

Specially Designed For IGBT Driver DC-DC Converter

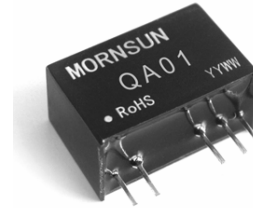

QA01 is specially designed for the IGBT driver which needs two isolation power supply. With two independent outputs, it can be better to supply power to the ON/OFF driver. The module also provides functions of short circuit protection and self-recovery capability.

FEATURES

- Input: 14.5 ~15.5VDC
- Output: 15V, 80mA
- Efficiency up to 80%
- Small footprint
- SIP package
- Good temperature identity
- Output short circuit protection
- 3000VAC isolation
- Operation temperature: -40°C ~ +85°C
- No external component required
- Could be operated under no load
- RoHS compliance

APPLICATION

- General-purpose Inverter
- AC Servo Systems
- Uninterruptable Power Supplies(UPS)
- Welding Machines

RECOMMENDED TO SUPPLY THE FOLLOWING IGBT DRIVERS

- QC962
- M57962 Series

MORNSUN Science & Technology Co.,Ltd.

Address: No. 5, Kehui St. 1, Kehui development center, Science Ave., Guangzhou Science City, Luogang district, Guangzhou, P.R.China.

Tel: 86-20-28203030

Fax:86-20-28203068

[Http://www.mornsun-power.com](http://www.mornsun-power.com)

Absolute Maximum Ratings

Item	Test Conditions	Limit	Units
Supply Voltage	V_{IN} DC	16	V
Output Current	$Io1$ $V_{IN}=15VDC$, PIN6&PIN7	80	mA
	$Io2$ $V_{IN}=15VDC$, PIN5&PIN6	40	mA
Isolation Voltage (input/output)	V_{ISO} Sine wave voltage 50Hz/60 Hz, 1mA max, 1 min.	3000	V
Operation Temperature	T_{opr}	-40 ~ +85	°C
Storage Temperature	T_{stg}	-50 ~ +125	°C

Notes: 1. $T_a=25^{\circ}C$, unless otherwise specified;
2. Other input modules are also available in our company.

Electrical Characteristic

Item	Test Conditions	Limit			Units
		Min.	Typ.	Max.	
Supply Voltage	V_{IN} Recommended Range	14.5	15.0	15.5	V
Output Voltage	$Vo1$ $V_{IN}=15VDC$ PIN6&PIN7 $Io1=80mA$	14	15	16	V
	$Vo2$ $V_{IN}=15VDC$ PIN5&PIN6 $Io2=40mA$	7	8.7	10	V
Line Regulation	V_{IN} change of 1%		1.3	1.5	%
Efficiency	η PIN6&PIN7 $Io1=80mA$		80		%
Isolation Capacitor (input/output)	C 1KHz, 1V		6.6		pF
Ripple & Noise*	V_{p-p} PIN6&PIN7 $Io1=80mA$		80	150	mV

Notes: $T_a=25^{\circ}C$; $V_D=15V$, unless otherwise specified.

Testing Circuit

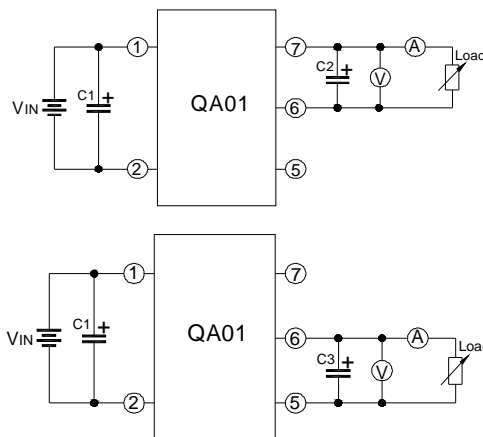

C1, C2, C3: 100 μ F/35V (Low impedance)

Application Circuit

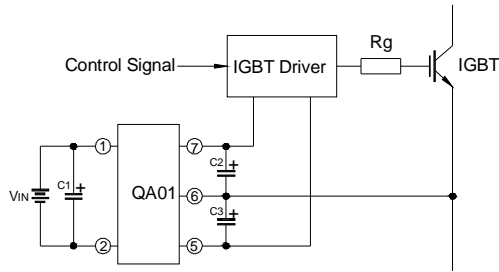

V_{IN} : 15VDC
 C1: 100 μ F/35V(Low impedance)
 C2: 100 μ F/35V(Low impedance)
 C3: 100 μ F/35V(Low impedance)

Application Notes

1. The wire between the converter and IGBT driver must as short as possible;
2. External filter capacitors should be connected as close as possible to the converter and the IGBT driver;
3. To ensure the high peak gate current, the filter capacitors should be low impedance.
4. The output average power of the IGBT driver should be less than the output power of DC-DC module.
5. In order to avoid over temperature damage for long time short-circuit, the recommended short-circuit time is less than ten minutes at 25°C.

Efficiency and Out Voltage to Out Current Characteristics

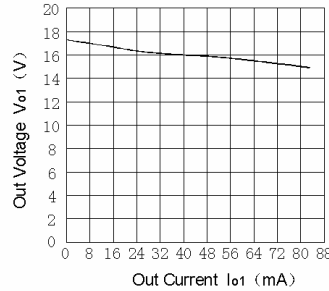
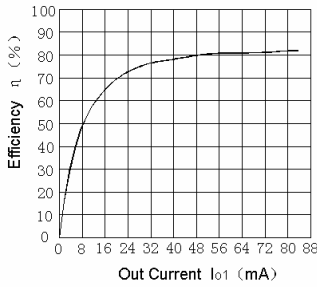

Outline Dimensions

MECHANICAL DIMENSIONS

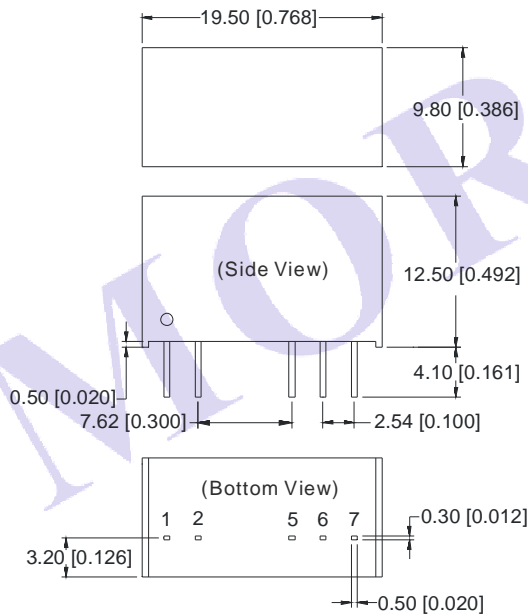

FOOTPRINT DETAILS

Pin	Function
1	Vin
2	GND
5	-Vo
6	0V
7	+Vo

Note:
 Unit:mm[inch]
 Pin section tolerances: ± 0.10 mm[± 0.004 inch]
 General tolerances: ± 0.25 mm[± 0.010 inch]

RECOMMENDED FOOTPRINT

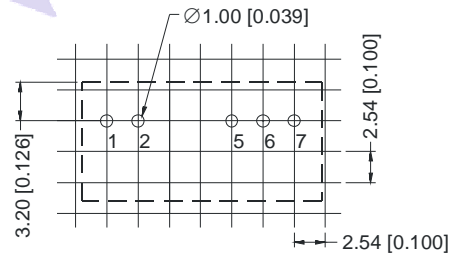

TUBE OUTLINE DIMENSIONS

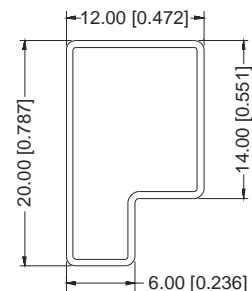

Note:
 Unit :mm[inch]
 General tolerances: ± 0.50 mm[± 0.020 inch]
 L=530mm[20.866inch] Devices per tube: 25pcs
 L=220mm[8.661inch] Devices per tube: 10pcs
 Short tube inside package dimensions: 255*170*80mm Net weight:115g
 Short tube outside package dimensions:375*280*270mm Net weight:625g
 Long tube inside package dimensions: 580*200*100mm Net weight:270g
 Long tube outside package dimensions(install two inside package box): 600*215*220mm Net weight:520g
 Long tube outside package dimensions(install three inside package box):600*215*325mm Net weight:660g